

# Digital mass flow controller

## Standard gas, low flow rate models

### Overview

The MQV series features high-performance digital mass flow controllers that incorporate a thermal mass flow sensor developed by Azbil Corporation, the  $\mu\text{F}$  (Micro Flow™) sensor, in addition to a proportional solenoid valve and advanced actuator control technology. In anticipation of customers' needs for high speed and wide-range mass flow controllability, these high-performance, low-price next-generation controllers are designed for general industrial use.

### Features

- 300 ms high-speed control.  
The ultra-high-speed response Micro Flow™ sensor and proprietary digital PID tuning deliver exceptionally high-speed performance in moving from a fully closed state to the set flow rate.  
MQV controllers also respond to changes in pressure on the primary side at high speed to minimize the effect on mass flow rates on the secondary side.
- The power circuit is isolated from analog I/O circuits. If multiple MQV controllers are connected to analog I/Os by a PLC or the like, there is no need to use an isolated circuit in the analog module on the PLC side. A common power supply can be used to supply power to the MQV.
- MQV controller can operate at a low differential pressure of 50 kPa or even less.  
The MQV is suitable low-pressure control applications such as burner air-fuel ratio control.

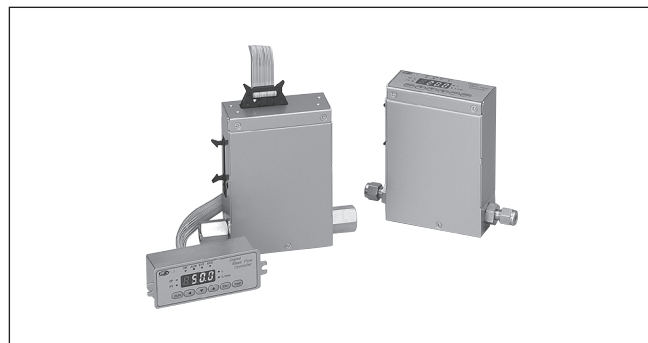

- MQV controllers offer a wide control range of 1 % FS to 100 % FS.
- Either an integrated display model or a separate display model can be selected according to the application needs.
- MQV controllers can be used over a wide operating temperature range ( $-10\text{ }^{\circ}\text{C}$  to  $+60\text{ }^{\circ}\text{C}$ ).
- An AC adapter is also available that is suitable for use in a laboratory setting or for similar application.

### Specifications

Item	Description									
	MQV9005	MQV9020	MQV9200	MQV9500	MQV0002	MQV0005	MQV0020	MQV0050 (B,C)	MQV0100	
Valve type	Proportional solenoid valve									
Valve operation	Normally closed when de-energized (N.C.)									
Standard full scale (FS) flow rate*1	5.00 mL/min (standard)	20.0 mL/min (standard)	200 mL/min (standard)	0.500 L/min (standard)	2.00 L/min (standard)	5.00 L/min (standard)	20.0 L/min (standard)	50.0 L/min (standard)	100.0 L/min (standard)	
Gas type	Air/nitrogen (N <sub>2</sub> ), oxygen (O <sub>2</sub> ), argon (Ar)		Air/nitrogen (N <sub>2</sub> ), oxygen (O <sub>2</sub> ), argon (Ar), carbon dioxide (CO <sub>2</sub> ), city gas 13A (LNG: 45 MJ/m <sup>3</sup> ), city gas 13A (LNG: 46 MJ/m <sup>3</sup> ), 100 % methane (CH <sub>4</sub> ), 100 % propane (C <sub>3</sub> H <sub>8</sub> ), and 100 % butane (C <sub>4</sub> H <sub>10</sub> ).				Air/nitrogen (N <sub>2</sub> ), oxygen (O <sub>2</sub> ), argon (Ar), carbon dioxide (CO <sub>2</sub> ),			
Gas must be dry and not contain corrosive components (chlorine, sulfur, acid). The gas must also be clean, not containing dust or oil mist. *2										
Control	Range	2 to 100 % FS (see Table 1 on page 4.)	1 % FS to 100 % FS (see Table 1 on page 4.)							
	Valve output update cycle	5 ms								
	Response (at standard differential pressure)	Within 0.5 s at setting $\pm 2\%$ FS (typ.)		Within 0.3 s at setting $\pm 2\%$ FS (typ.)						
	Accuracy (at the standard temperature and standard differential pressure, Q; flow rate) <sup>3</sup>	$\pm 1\%$ FS High-accuracy models are not available.		(1) Standard models: $\pm 0.5\%$ FS ( $0\% \text{ FS} \leq Q \leq 50\% \text{ FS}$ ) $\pm 1\%$ FS ( $50\% \text{ FS} < Q \leq 100\% \text{ FS}$ )				(2) High-accuracy models: $\pm 0.2\%$ FS ( $0\% \text{ FS} \leq Q < 20\% \text{ FS}$ ) $\pm 1\%$ SP ( $20\% \text{ FS} \leq Q \leq 100\% \text{ FS}$ ) *4		
Standard models: $\pm 1\%$ FS ( $0\% \text{ FS} \leq Q \leq 80\% \text{ FS}$ ) $\pm 2\%$ FS ( $80\% \text{ FS} < Q \leq 100\% \text{ FS}$ ) High-accuracy models are not available.										

Item		Description									
		MQV9005	MQV9020	MQV9200	MQV9500	MQV0002	MQV0005	MQV0020	MQV0050 (B,C)	MQV0100	
Control	Repeatability	± 0.5 % FS High-accuracy models are not available.		(1) Standard models ± 0.25 % FS (0 % FS ≤ Q ≤ 50 % FS) ± 0.5 % FS (50 % FS < Q ≤ 100 % FS) (2) High-accuracy models: ± 0.1 % FS (0 % FS ≤ Q < 20 % FS) ± 0.5 % SP (20 % FS ≤ Q ≤ 100 % FS) *4					Standard models: ± 0.5 % FS (0 % FS ≤ Q ≤ 80 % FS) ± 1 % FS (80 % FS < Q ≤ 100 % FS) High-accuracy models are not available.		
	Temperature characteristics	0.06 % FS max. per 1 °C *3						0.08 % FS max. per 1 °C	0.06 % FS max. per 1 °C		
	Pressure characteristics	0.2 % FS max. per 100 kPa*3				0.4 % FS max. per 100 kPa	0.2 % FS max. per 100 kPa				
Pressure	Standard differential pressure	100 kPa (Inlet pressure = 100 kPa [gauge], outlet pressure = 0 kPa [gauge])		200 kPa (Inlet pressure = 200 kPa [gauge], outlet pressure = 0 kPa [gauge])			150 kPa (Inlet pressure = 150 kPa [gauge], outlet pressure = 0 kPa [gauge])	200 kPa (Inlet pressure = 200 kPa [gauge], outlet pressure = 0 kPa [gauge])		300 kPa (Inlet pressure = 300 kPa [gauge], outlet pressure = 0 kPa [gauge])	
	Required differential pressure*5	5 kPa	30 kPa	50 kPa	5 kPa	50 kPa	5kPa	50 kPa	100 kPa	250 kPa	
	Operating differential pressure range	300 kPa max.								400 kPa max.	
	Allowable inlet pressure	-0.07 to 0.5 MPa [gauge]*6									
	Pressure resistance	1 MPa [gauge]									
Temperature	Standard operating temperature	+ 23 °C									
	Allowable operating temperature range	-10 to +60 °C									
	Allowable storage temperature range	-20 to +70 °C									
Humidity	Allowable operating humidity range	10 to 90 % RH (without condensation)									
External leaks	Helium leak rate	Within 1 × 10 <sup>-6</sup> Pa·m <sup>3</sup> /s (with VCR connection only)									
Flow rate setup	Setup method	(1) Key operation, (2) External analog input, (3) Dedicated loader communication*7, (4) RS-485 communications (3 wire-system)*8									
	Setup resolution	See Table 1 on page 4.									
	External analog input	Input range: 0 to 5 Vdc/1 to 5 Vdc/0 to 20 mA/4 to 20 mA (switchable) Input impedance: Voltage input type: 1 MΩ ± 10 %, Current input type: 250 Ω ± 10 %									
Flow rate display	Display method	7-segment LED, 4 digits									
	Setup resolution	See Table 1 on page 4.									
	Indication accuracy (at the standard temperature and standard differential pressure, Q; flow rate)	± 1 % FS ± 1 digit		(1) Standard models: 0.5 % FS ± 1 digit (0 % FS ≤ Q ≤ 50 % FS) ± 1 % FS ± 1 digit (50 % FS < Q ≤ 100 % FS) (2) High-accuracy models: ± 0.2 % FS ± 1 digit (0 % FS ≤ Q < 20 % FS) ± 1 % rdg ± 1 digit (20 % FS ≤ Q ≤ 100 % FS)					Standard models: ± 1 % FS ± 1 digit (0 % FS ≤ Q ≤ 80 % FS) ± 2 % FS ± 1 digit (80 % FS < Q ≤ 100 % FS) High-accuracy models are not available.		
Totalizing function	Display range	0.0 to 9,999,999.9 mL	0 to 99,999,999 mL	0.00 to 999,999.99 L	0.00 to 999,999.99 L	0.0 to 9,999,999.9 L	0.0 to 9,999,999.9 L	0 to 99,999,999 L	0 to 99,999,999 L	0.00 to 999,999.99 m <sup>3</sup>	
	Display resolution	0.1 mL	1 mL	0.01 L	0.01 L	0.1 L	0.1 L	1 L	1 L	0.01 m <sup>3</sup>	
	Totalized count backup timing	(1) Every 50 mL	(1) Every 200 mL	(1) Every 2 L	(1) Every 5 L	(1) Every 20 L	(1) Every 50 L	(1) Every 200 L	(1) Every 500 L	(1) Every 1 m <sup>3</sup>	
		(2) Once per hour after the previous backup, (3) At the time the RUN key is pressed.									
Analog output	Output type	Instantaneous flow rate (PV) output or setting flow rate (SP) output (switchable)									
	Output scale	0 to full-scale flow rate (scale can be changed)									
	Output range	0 to 5 Vdc/1 to 5 Vdc/0 to 20 mA/4 to 20 mA (switchable)									
	Max. output	7 Vdc or 28 mA (max. output when flow rate exceeds the range)									
	Accuracy	Total output accuracy ± 0.3 % FS indication accuracy ± 0.3 % FS									
	External resistance	Voltage output type: 250 kΩ min., Current output type: 300 Ω max.									
Alarm/event output	Number of outputs	Alarm output: 1, Event output: 2									
	Output rating	30 Vdc, 30 mA max. (Non-isolated open collector output)									
	Totalized pulse output width	100 ms ± 10 % (when pulse output is selected in the function setup)									
	Totalized pulse output rate	0.1 mL/pulse	1 mL/pulse	0.01 L/pulse		0.1 L/pulse		1 L/pulse	0.01 m <sup>3</sup> /pulse		
External switching input	Input type, number of inputs	External 3-way switching input (OPEN/GND/5V): 1 External contact input (2-way switching): 3									
	Required circuit type	Non-voltage contacts or open collector									
	Contact OFF terminal voltage	External 3-way switching input: 2.5 ± 0.5 V External contact input: 2.8 ± 0.5 V									
	Contact ON terminal current	Approx. 0.5 mA (current flowing to contact)									
	Allowable ON contact resistance	250 Ω max.									
	Allowable OFF contact resistance	100 kΩ min.									
	Allowable ON residual voltage	1.0 V max. (open collector type)									
Allowable OFF leakage current	50 μA max. (open collector type)										
Reference voltage output	Output rating	5.0 Vdc ± 5 %, 5 mA max.									
	Application	Reference voltage for flow rate set voltage and for 5 V input of external 3-way switching input									
Communications	Mode	(1) Dedicated loader communications*7, (2) RS-485 communications (3-wire system) *8									
	Transmission speed	2400, 4800, 9600, 19200, 38400 bps (19200 bps: loader communication only)									

Item		Description								
		MQV9005	MQV9020	MQV9200	MQV9500	MQV0002	MQV0005	MQV0020	MQV0050 (B,C)	MQV0100
Power supply	Rating	24 Vdc, current consumption: 300 mA max.								
	Allowable power voltage range	21.6 to 26.4 V								
		(ripple 5 % max.)								
	Isolation	The power circuit is isolated from the input/output circuit.								
Connection method		1/4" Swagelok, 1/4" VCR			9/16"-18 UNF, 1/4" Rc, 1/4" Swagelok, 1/4" VCR				9/16"-18 UNF, 1/4" Rc, 3/8" Swagelok	
Mounting orientation		Horizontal. Be sure that display surface does not face down.								
Mass		Approx. 1.1 kg			Approx. 1.2 kg					
Applicable standards		EN61326-1: 2013 EN61326-2-3: 2013								

Notes:

- \*1. mL/min. and L/min. (standard) indicate the volumetric flow rate per minute (mL/min. or L/min.) converted to conditions of 20 °C and 101.325 kPa (1 atm). The reference temperature can be changed to 0 °C, 25 °C, or 35 °C. The controllable flow rate range, which is the value for air/nitrogen, varies depending on the gas type. See Table 1 on page 4.
- \*2. Prevent foreign matter from entering the device. If rust, water droplets, oil mist, or dust in the pipes enter the device, measurement or control error or damage might occur. If there is a possibility of foreign matter entering the device, provide a filter, strainer or mist trap capable of eliminating foreign matter 0.1 µm or greater in diameter on the upstream side. Be sure to inspect and replace the filter at regular intervals.
- \*3. For air/nitrogen and oxygen (for the oxygen model).
- \*4. ± x.x % SP indicates the accuracy of the control flow rate for the set flow rate.
- \*5. Differential pressure required for obtaining full-scale flow rate. (Outlet pressure = 0 kPa (gauge).) Operation is possible even below the required differential pressure, but the controllable flow rate range becomes narrower. See the graphs for differential pressure vs. flow rate on page 5.
- \*6. For information on the advisability of using an inlet pressure greater than 0.5 MPa (gauge), contact the azbil Group.
- \*7. Requires a dedicated loader package (MLP100A100) sold separately.
- \*8. Only models with the RS-485 communications option.

## Functions

Function	Description
Flow rate totalization	Integrated flow count can be up to eight digits long (to 99,999,999) for each unit. (For display resolutions, see specificaiton table.)
Alarm lamp/output/blocking	An upper/lower limit flow rate alarm and a valve drive current alarm can be set to respond to deviation of the instantaneous flow rate from the set flow rate. The valve can be forcibly opened/closed during an alarm.
OK lamp	The OK lamp can be set to light when the control flow rate is within the set value ± allowable range.
Event lamp / event output	<ul style="list-style-type: none"> <li>• Integrated flow event output</li> <li>• Totalized pulse output rate</li> <li>• OK output</li> <li>• Output mode</li> </ul> Two of the event types listed above can be selected.
Automatic shut-off	The valve can be shut off automatically under the following conditions: <ul style="list-style-type: none"> <li>• When the totalized flow count reaches the preset value.</li> <li>• When one of the alarms, including flow rate alarms, is triggered.</li> </ul> Note: The valve on this device cannot completely shut off a flow.
Automatic reset of cumulative count at start of control	This function can be used to reset the cumulative count simultaneously with the start of control operation using key operation or external contact input.
Valve forcibly open or close	This function can be used to fully open/close the valve using key operation or external contact input.
Multi-setup	Quickly switch to one of eight preset flow values by key operation or external input.
Direct setup function	Settings can be changed with just the ▲ and ▼ keys instead of a complex operation process.
Full multi-range setup	The control range can be set freely from 100 % down to 10 % of the standard range in 1 % FS increments. The control range can be set freely according to the application. Additionally, two preset control flow ranges can be switched by external contact input. This function can also be used to change the resolution setting.
Slow start	Sudden changes in the controlled flow rate, when control is started or when the set value is changed, can be suppressed.
Gas type switching	The gas type to be used can be selected from the standard compatible gases by key operation. Additionally, two kinds of gas type settings can be changed by external contact input.
Gas type setup	The user can set gas type conversion factors for gases other than the standard compatible gases, and for mixed gases.
SP ramp control	Two SP change rates (gradients) can be specified at the start of control operation or when changing settings. Also, an external switch can be connected to the device and used to switch the rate.
Valve drive current alarm	This function monitors the amount of current driving the proportional valve and outputs an alarm under certain conditions. Note: when setting the alarm, that the amount of differential pressure and other factors may cause fluctuations in the valve drive current even if the set flow rate is uniform..
Loader communications	A communications port for loader communications is included as standard equipment. The dedicated loader package (MLP100A100), sold separately, enables one-to-one serial communication with a PC. (Various types of settings and monitor display settings can be completed on the PC display screen.)
RS-485 communication (option)	Three-wire RS-485 communication is also available as an option. (Transmission speed: 2400 bps to 38400 bps)

Table 1. Control flow rate range and setup/display resolution

(Unit: For MQV9005, MQV9020, and MQV9200: mL/min. (standard), for all other models: L/min. (standard)).

Gas type	MQV9005		MQV9020		MQV9200		MQV9500	
	Control flow rate range	Setup/display resolution* <sup>2</sup>	Control flow rate range	Setup/display resolution* <sup>2</sup>	Control flow rate range	Setup/display resolution* <sup>2</sup>	Control flow rate range	Setup/display resolution* <sup>2</sup>
Air/nitrogen	0.10 to 5.0	0.02	0.2 to 20.0	0.1	2 to 200	1	0.004 to 0.500	0.002
Oxygen	0.10 to 5.00	0.02	0.2 to 20.0	0.1	2 to 200	1	0.004 to 0.500	0.002
Argon	0.10 to 5.00	0.02	0.2 to 20.0	0.1	2 to 200	1	0.004 to 0.500	0.002
Carbon dioxide	–	–	–	–	1.0 to 120.0	0.5	0.003 to 0.300	0.001
City gas (LNG: 45 MJ/m <sup>3</sup> )* <sup>3</sup>	–	–	–	–	2 to 200	1	0.004 to 0.500	0.002
City gas (LNG: 46 MJ/m <sup>3</sup> )* <sup>3</sup>	–	–	–	–	2 to 200	1	0.004 to 0.500	0.002
100 % methane	–	–	–	–	2 to 200	1	0.004 to 0.500	0.002
100 % propane	–	–	–	–	0.6 to 60.0	0.2	0.002 to 0.160	0.001
100 % butane	–	–	–	–	0.4 to 50.0	0.2	1.0 to 120.0 <sup>1</sup>	0.5 <sup>1</sup>

Gas type	MQV0002		MQV0005		MQV0020		MQV0050 (B,C)	
	Control flow rate range	Setup/display resolution* <sup>2</sup>	Control flow rate range	Setup/display resolution* <sup>2</sup>	Control flow rate range	Setup/display resolution* <sup>2</sup>	Control flow rate range	Setup/display resolution* <sup>2</sup>
Air/nitrogen	0.02 to 2.00	0.01	0.04 to 5.00	0.02	0.2 to 20.0	0.1	0.4 to 50.0	0.2
Oxygen	0.02 to 2.00	0.01	0.04 to 5.00	0.02	0.2 to 20.0	0.1	0.4 to 50.0	0.2
Argon	0.02 to 2.00	0.01	0.04 to 5.00	0.02	0.2 to 20.0	0.1	0.4 to 50.0	0.2
Carbon dioxide	0.010 to 1.200	0.005	0.03 to 3.00	0.01	0.10 to 12.00	0.05	0.3 to 30.0	0.1
City gas (LNG: 45 MJ/m <sup>3</sup> )* <sup>3</sup>	0.02 to 2.00	0.01	0.04 to 5.00	0.02	0.2 to 20.0	0.1	0.4 to 50.0	0.2
City gas (LNG: 46 MJ/m <sup>3</sup> )* <sup>3</sup>	0.02 to 1.60	0.01	0.04 to 5.00	0.02	0.2 to 20.0	0.1	0.4 to 50.0	0.2
100 % methane	0.02 to 2.00	0.01	0.04 to 5.00	0.02	0.2 to 20.0	0.1	0.4 to 50.0	0.2
100 % propane	0.006 to 0.600	0.002	0.02 to 1.60	0.01	0.06 to 6.00	0.02	0.2 to 16.0	0.1
100 % butane	0.004 to 0.400	0.002	0.010 to 1.200	0.005	0.04 to 4.00	0.02	0.10 to 10.00	0.05

Gas type	MQV0100	
	Control flow rate range	Setup/display resolution* <sup>2</sup>
Air/nitrogen	1.0 to 100.0	0.5
Oxygen	1.0 to 100.0	0.5
Argon	1.0 to 100.0	0.5
Carbon dioxide	1.0 to 80.0	0.5
City gas (LNG: 45 MJ/m <sup>3</sup> )* <sup>3</sup>	–	–
City gas (LNG: 46 MJ/m <sup>3</sup> )* <sup>3</sup>	–	–
100 % methane	–	–
100 % propane	–	–
100 % butane	–	–

\*1. The flow rate display unit is [mL/min.] when the gas type is set to 100% butane on the MQV9500.

\*2. Contact Azbil Corporation for assistance with setting input and flow rate output with analog signals as it will help increase resolution dramatically.

\*3. City gas 13A is based on the gases shown below, which are produced from LNG. If the composition of your city gas (LNG) is different, contact Azbil Corporation.

Gas type name	Methane (%)	Ethane (%)	Propane (%)	Butane (%)
City gas 13A-46MJ	88	5.8	4.5	1.7
City gas 13A-45MJ	88.9	6.8	3.1	1.2

Relationship of differential pressure and flow rate with valve fully open (for air)

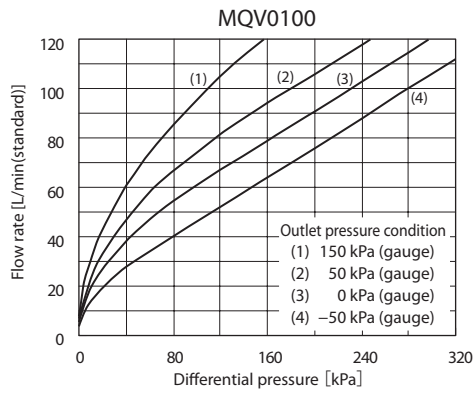
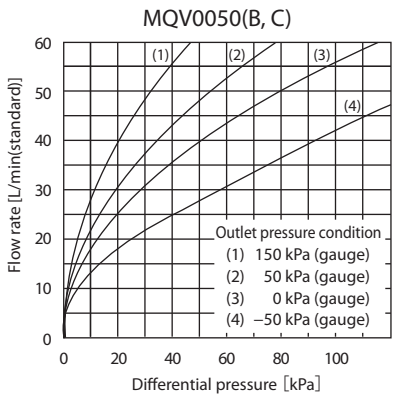
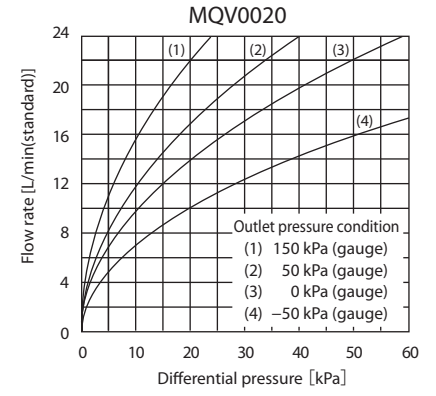
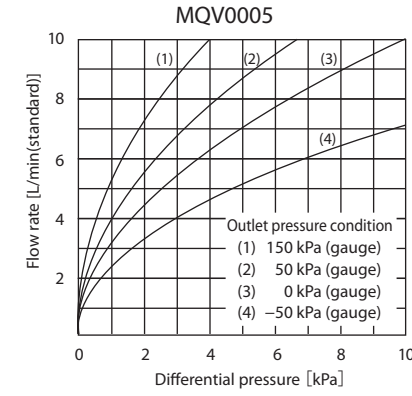
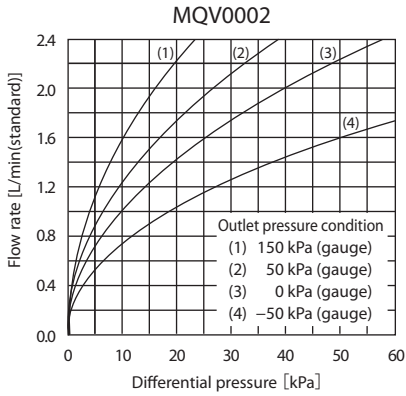
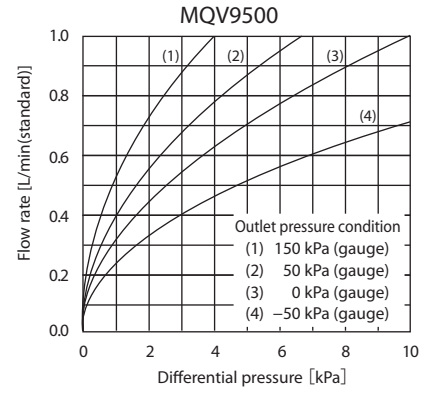
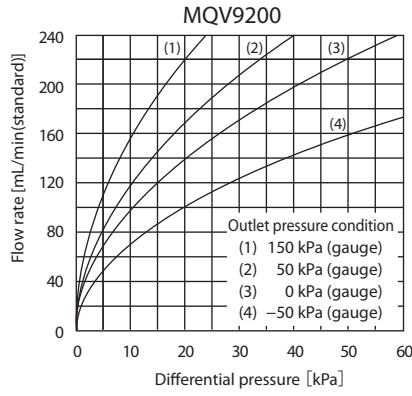
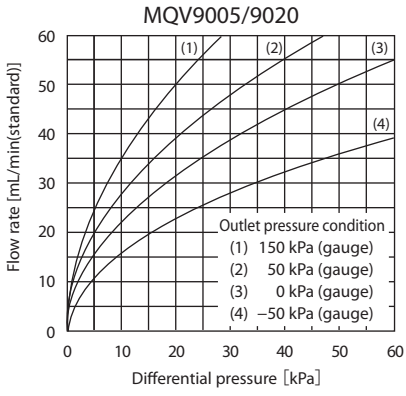

## ! Handling Precautions

- If the outlet pressure is different from the values graphed on the previous page, calculate the flow rate using the appropriate equation below.

(1) When  $P2 / P1 > 0.53$ ,

$$Q = C1 \sqrt{(P1 - P2)P2}$$

(2) When  $P2 / P1 \leq 0.53$ ,

$$Q = C2 \cdot P1$$

P1: Inlet absolute pressure [kPa (abs)]

P2: Outlet absolute pressure [kPa (abs)] (Absolute pressure = gauge pressure + 101.3 kPa)

Q: Flow rate [L/min (standard)]

((mL/min (standard)) for MQV9200)

C1 and C2: Constant values by model

- MQV9005: C1= 0.7097, C2=0.4653
- MQV9020: C1= 0.7097, C2=0.4653
- MQV9200: C1= 3.123, C2=1.559
- MQV9500: C1= 0.03123, C2=0.01559
- MQV0002: C1= 0.03123, C2=0.01559
- MQV0005: C1= 0.3123, C2=0.1559
- MQV0020: C1= 0.3123, C2=0.1559
- MQV0050B/C: C1= 0.5529, C2=0.2760
- MQV0100: C1= 0.6031, C2=0.3011

Specific gravity of standard compatible gas  
(air is taken as 1.0)

Gas type	Specific gravity
Oxygen	1.11
Argon	1.38
Carbon dioxide	1.53
City gas 13A (LNG)	0.64
100 % methane	0.56
100 % propane	1.56
100 % butane	2.08

When used with the gases other than air, convert the flow rate using the following equation:

- Flow rate = Flow rate in air  $\div \sqrt{\text{specific gravity of gas to be controlled}}$

Example: When using the MQV0002 with CO<sub>2</sub>, inlet pressure = 10 kPa (gauge), and outlet pressure = 0 kPa (gauge),

$$1.0 \text{ L/min(standard)} \div \sqrt{1.53} = 0.81 \text{ L/min (standard)}$$

## Wiring

### ● Connector pin layout

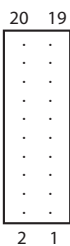

View from connector  
insertion side

Connector model No. (device side): HIF3BA-20PA-2.54DS (manufacturer: HIROSE ELECTRIC CO., LTD.)

Table of compatible connectors

Connector type	Compatible connector model No.	Compatible contact model No.	Compatible wire
Contact crimp type	HIF3BA-20D-2.54C	HIF3-2226SCC	AWG#22 to #26 (individual wires OK)
Cable clamp type	HIF3BA-20D-2.54R	Not required	AWG#28 (flat cable only)

### ● Connector signal names

Pin number	Signal name	Description	Remarks
20	+5 V (5 mA max.)	5 Vdc reference voltage output	5 mA max.
19	FLOW OUT	Instantaneous flow rate (PV) or flow rate set point (SP) output	0 to 5 V/1 to 5 V/0 to 20 mA/4 to 20 mA output
18	A.GND	Analog ground	Analog signal common
17	FLOW SP INPUT	Set point flow rate (SP) voltage input	0 to 5 V/1 to 5 V/0 to 20 mA/4 to 20 mA input
16	MODE INPUT	External 3-way switching	3-stage switching input (OPEN/GND/5V)
15	DI3	External contact input 3	2-stage switching input (OPEN/GND)
14	DI2	External contact input 2	
13	DI1	External contact input 1	
12	EV2 OUT	Event output 2	Open collector non-insulated output
11	EV1 OUT	Event output 1	
10	ALM OUT	Alarm output	
9	D.GND	Digital ground	
8	DB	RS-485 communications DB	Do not connect on models without the communications function.
7	DA	RS-485 communications DA	
6	D.GND	Digital ground	Digital signal common
5	TEST	For test	Do not use
4	POWER GND	Power supply ground	Connect two wires each in parallel to the power supply to reduce voltage drop caused by wiring resistance.
3	POWER GND	Power supply ground	
2	POWER (24 V)	Power supply + (24 Vdc)	
1	POWER (24 V)	Power supply + (24 Vdc)	

## ● Example of wiring

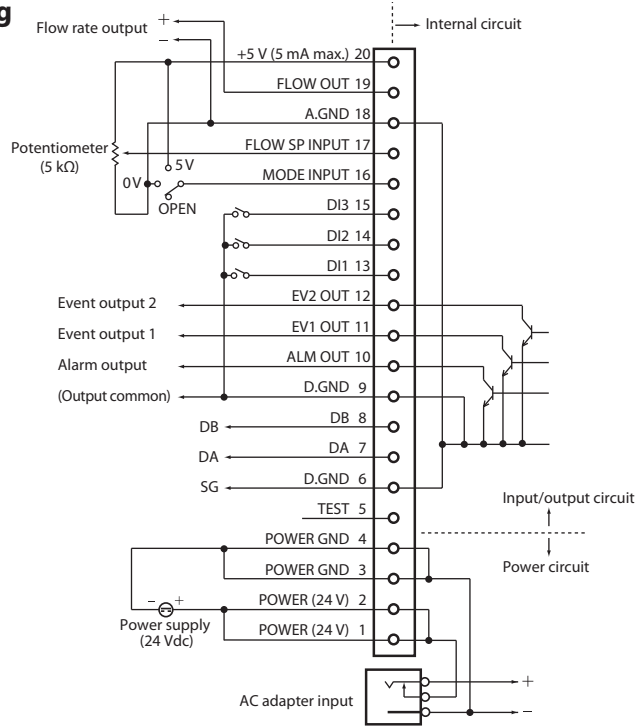

- Do not input any signal to pin No. 5.
- The power circuit is isolated from the Input/output circuit inside this device.
- Even though the analog GND and digital GND are connected internally, always carry out the grounding wiring individually.
- When the AC adapter plug is inserted into the AC adapter power supply terminal, the power supply changes from the DC power supply to the AC adapter.
- The previous AC adapter, No. 81446682-001 (15 Vdc, 350 mA), cannot be used with this MQV.

### \*1. Analog I/O

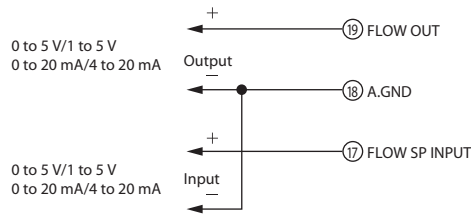

### \*2. External 3-way switching input

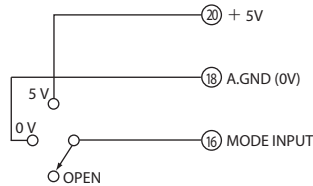

## ! Handling Precautions

- When switching by relay, use an appropriate relay intended for microcurrent use (with gold contacts). Failure to do so could cause faulty contact, resulting in malfunction.

### Operation of external 3-way switching input

Assigned function		Input state of pin No.16		
		OPEN	0V	5V
Switching of operating mode 1		Control	Fully closed	Fully open
Switching of SP No.		SP-0	SP-1	SP-2
Switching of totalizing operation		Continue counting	Reset	Stop counting
Switching of analog I/O voltage range	Input	Internal reference* 0 to 5 V or external reference 0 to 2 mA	External reference 0 to 5 V/0 to 20 mA	External reference 1 to 5 V/4 to 20 mA
	Output	0 to 5 V/0 to 20 mA	0 to 5 V/0 to 20 mA	1 to 5 V/4 to 20 mA
Switching of operating mode 2		Fully closed	Control	Fully open

\* "Internal reference" refers to the use of the 5 Vdc reference voltage pin (No. 20) on this device, and is used when the setting value is set by an externally connected potentiometer.

### \*3 When using potentiometer (0 to 5 V)

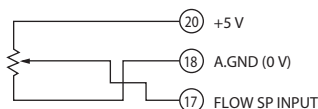

## Model selection guide

### ● Standard gas, low flow rate models

Basic model No.	Control flow rate range	Display	Body material	Connection method	Gas type	Optional functions 1	Optional functions 2	Optional functions 3	Optional functions 4	Optional functions 5	Appended No.	Description
MQV												Digital mass flow controller, MQV series
	9005											0.10 to 5.00 mL/min (standard) *1, *4
	9020											0.2 to 20.0 mL/min (standard) *1, *4
	9200											2 to 200 mL/min (standard) *1, *4
	9500											0.004 to 0.500 L/min (standard) *1, *4
	0002											0.02 to 2.00 L/min (standard) *1, *4
	0005											0.04 to 5.00 L/min (standard) *1, *4
	0020											0.2 to 20.0 L/min (standard) *1, *4
	0050											0.4 to 50.0 L/min (standard) *1, *4
		B										Integrated display (body length 90 mm)
		C										Separate display (body length 90 mm)
			S									SUS316
				R								1/4" Rc (cannot be selected for the MQV9005 or MQV9020)
				S								1/4" Swagelok
				V								1/4" VCR
				U								9/16"–18 UNF (cannot be selected for the MQV9005 or MQV9020)
					N							Air/nitrogen *2
					S							Oxygen *3
						0						Without optional functions
							0					Without optional functions
								1				Model with RS-485 communications (CPL) function
									0			Without optional functions
										0		Without optional functions
											1	Gas-contacting parts treated to be oil free *5
											0	Without optional functions
											D	With inspection certificate
											Y	With traceability certificate
											0	Product version

Basic model No.	Control flow rate range	Display	Body material	Connection method	Gas type	Optional functions 1	Optional functions 2	Optional functions 3	Optional functions 4	Optional functions 5	Appended No.	Description
MQV												Digital mass flow controller, MQV series
	0100											1.0 to 100.0 L/min (standard) *1, *4
		B										Integrated display (body length 90 mm)
		C										Separate display (body length 90 mm)
			S									SUS316
				R								1/4" Rc
				S								1/4" Swagelok
				U								9/16"–18 UNF
					N							Air/nitrogen *6
					S							Oxygen *7
						0						Without optional functions
							0					Without optional functions
								1				Model with RS-485 communications (CPL) function
									0			Without optional functions
										0		Without optional functions
											1	Gas-contacting parts treated to be oil free *5
											0	Without optional functions
											D	With inspection certificate
											Y	With traceability certificate
											0	Product version



## ● Standard gas, low flow rate, high-accuracy models

Basic model No.	Control flow rate range	Display	Body material	Connection method	Gas type	Optional functions 1	Optional functions 2	Optional functions 3	Optional functions 4	Optional functions 5	Appended No.	Description
MQV												Digital mass flow controller, MQV series
	9200											2 to 200 mL/min (standard) *1, *4
	9500											0.004 to 0.500 L/min (standard) *1, *4
	0002											0.02 to 2.00 L/min (standard) *1, *4
	0005											0.04 to 5.00 L/min (standard) *1, *4
	0020											0.2 to 20.0 L/min (standard) *1, *4
	0050											0.5 to 50.0 L/min (standard) *1, *4
		B										Integrated display (body length 90 mm)
		C										Separate display (body length 90 mm)
			S									SUS316
				R								1/4" Rc
				S								1/4" Swagelok
				V								1/4" VCR
					1							Air/nitrogen *2
					2							Oxygen *3
						S						High-accuracy
							0					Without optional functions
							1					Model with RS-485 communications (CPL) function
								0				Without optional functions
									0			Without optional functions
									1			Gas-contacting parts treated to be oil free *5
										Y		With traceability certificate
											0	Product version

### Notes:

- \*1. L/min (standard) indicates the volumetric flow rate per minute (L/min) converted to conditions of 20 °C and 101.325 kPa (1 atm). The reference temperature can be changed to 0, 25, or 35 °C.
- \*2. The MQV is set initially for air/nitrogen use before shipment from the factory. However, the gas type can be changed to argon, carbon dioxide (CO<sub>2</sub>), city gas 13A (LNG: 45 MJ/m<sup>3</sup>, LNG: 46 MJ/m<sup>3</sup>), 100 % propane, 100 % methane, or 100 % butane.
- \*3. The default setting is set to oxygen use before shipment from the factory. However, the gas type can be changed to air/nitrogen, argon, carbon dioxide (CO<sub>2</sub>), city gas 13A (LNG: 45 MJ/m<sup>3</sup>, LNG: 46 MJ/m<sup>3</sup>), 100 % propane, 100 % methane, or 100 % butane.  
Do not change it back to oxygen once the MQV has been used for any other gas even once.
- \*4. The controllable flow rate range varies depending on the gas type. See Table 1 on page 4.
- \*5. If oxygen is selected as the gas type, "1" (Gas-contacting parts treated to be oil free) must be selected in optional function 4.
- \*6. The default setting is set to air/nitrogen use before shipment from the factory. However, the gas type can be changed to argon (Ar) or carbon dioxide (CO<sub>2</sub>).
- \*7. The default setting is set to oxygen use before shipment from the factory. However, the gas type can be changed to air/nitrogen, argon, or carbon dioxide (CO<sub>2</sub>).  
Do not change it back to oxygen once the MQV has been used for any other gas even once.

## External dimensions

### ● Models with integrated display

- MQV9005 and MQV9020 accept 1/4" Swagelok and 1/4" VCR connections only.
- MQV0100 does not accept VCR connections.
- MQV0100 accepts 3/8" Swagelok couplings whereas other models accept 1/4" Swagelok couplings.

(Unit: mm)

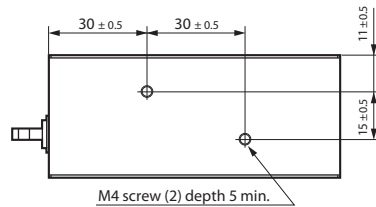
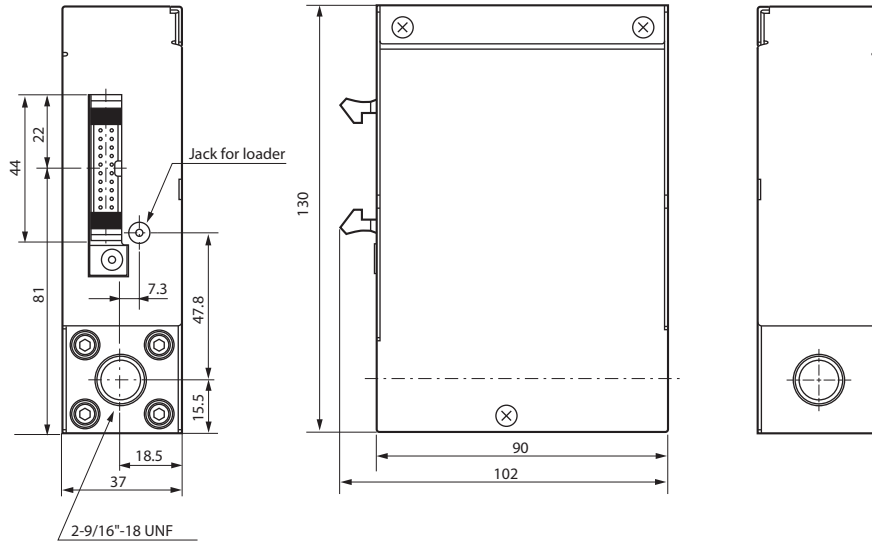
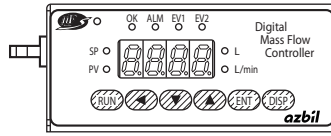

9/16"-18 UNF connection type (standard)

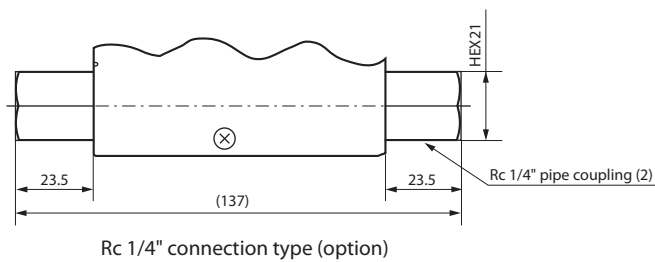

Rc 1/4" connection type (option)

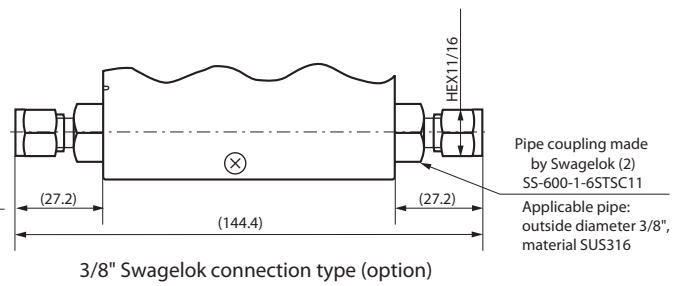

3/8" Swagelok connection type (option)

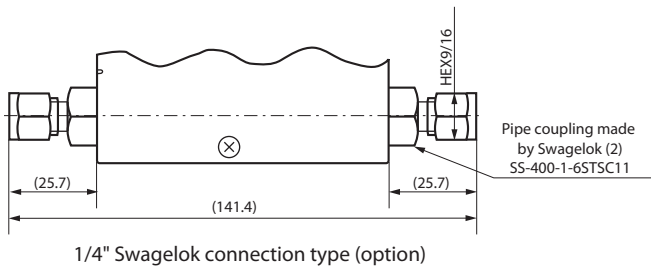

1/4" Swagelok connection type (option)

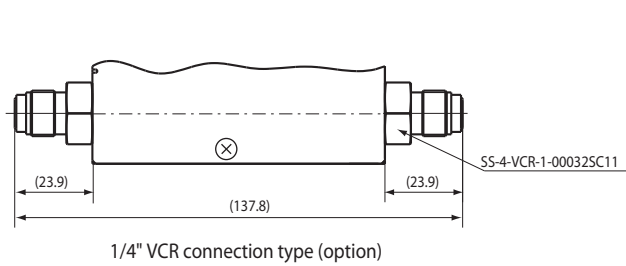

1/4" VCR connection type (option)

● **Model with separate display (main unit)**

- MQV9005 and MQV9020 accept 1/4" Swagelok and 1/4" VCR connections only.
- MQV0100 does not accept VCR connections.
- MQV0100 accepts 3/8" Swagelok couplings whereas other models accept 1/4" Swagelok couplings.

(Unit: mm)

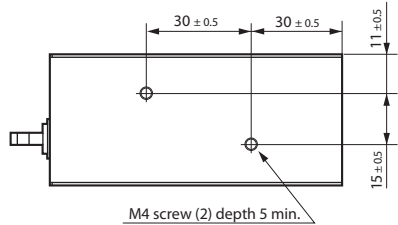
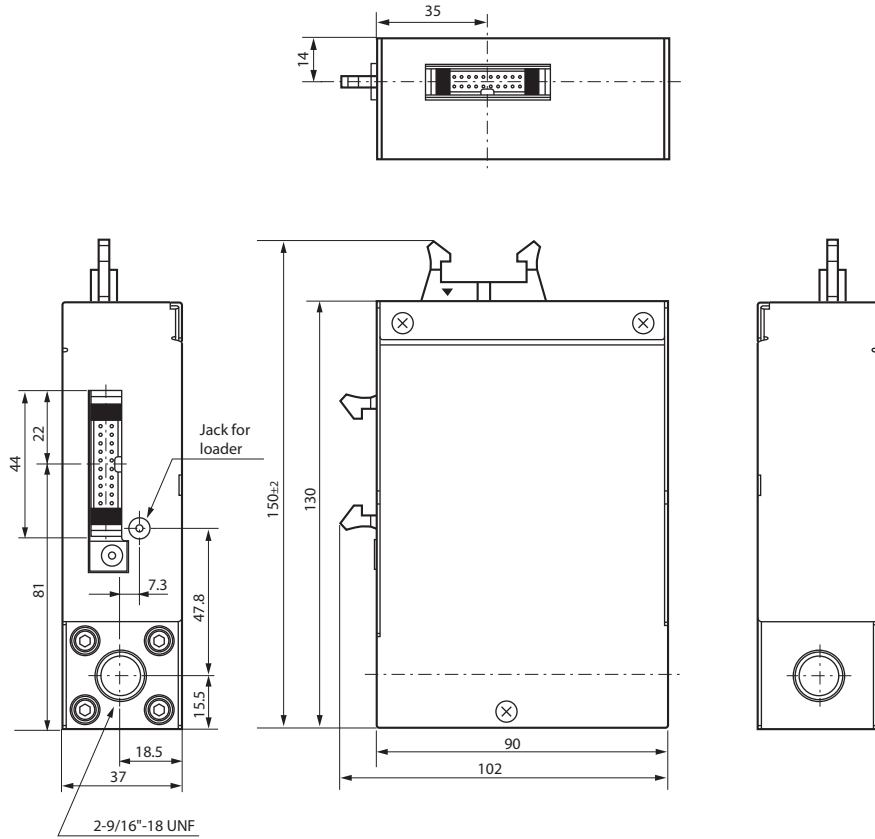

9/16"-18 UNF connection type (standard)

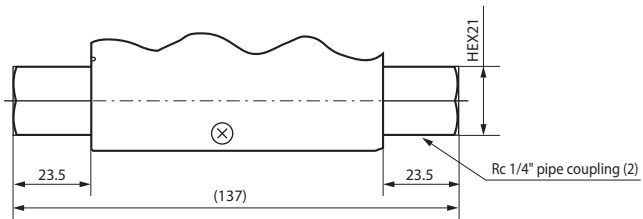

Rc 1/4" connection type (option)

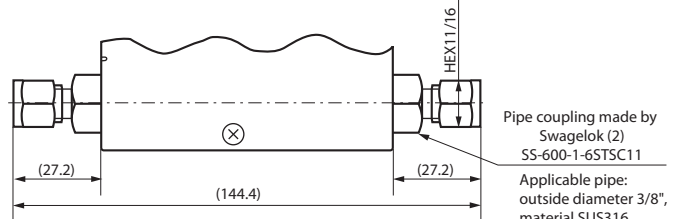

3/8" Swagelok connection type (option)

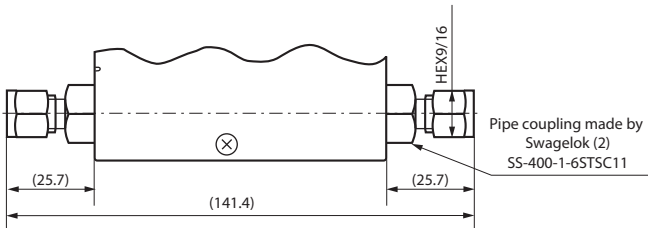

1/4" Swagelok connection type (option)

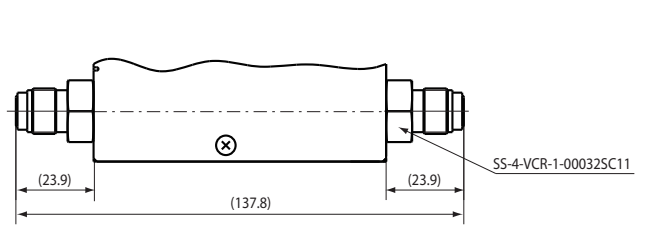

1/4" VCR connection type (option)

● Model with separate display (display)

(Unit: mm)

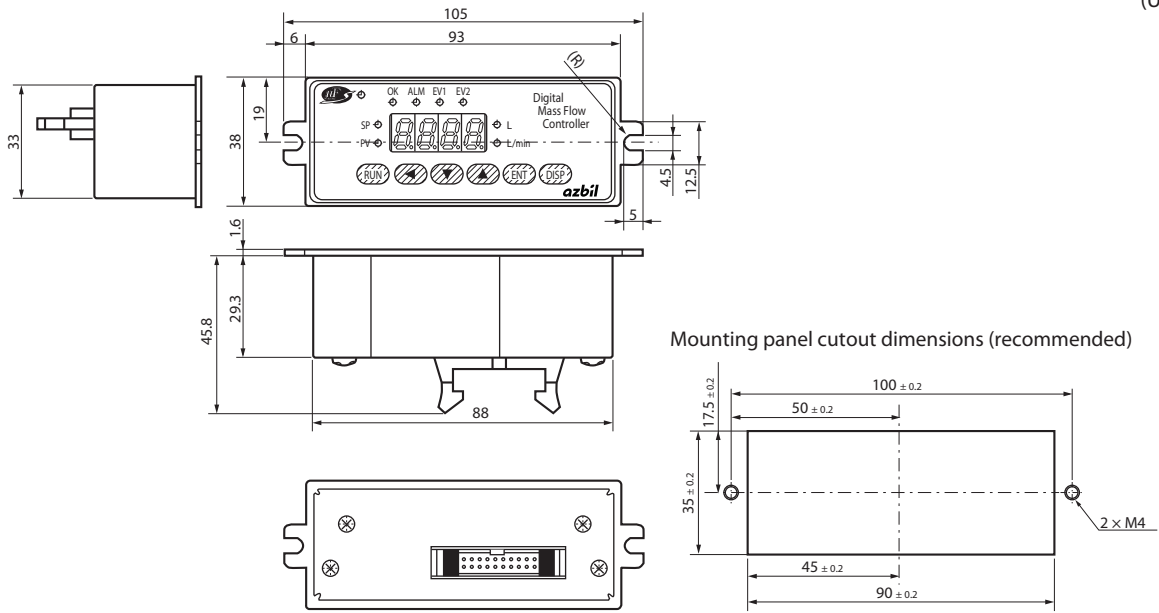

● Cable for connecting display to main unit

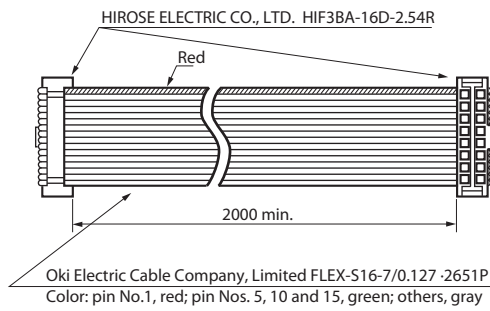

Table 2. Optional parts (sold separately)

Item	Model No.	Remarks
Cable with dedicated connector	81446681-001	20-wire flat cable, 2 m (AWG #24)
	81446951-001	20-wire shielded cable, 5 m
AC adapter	81446957-001	Rating Input rating: 100 to 240 V Output rating: 24 Vdc/750 mA Operating temperature range: 0 to 40 °C
Potentiometer for flow rate setting	81446683-002	5 kΩ with digital dial, 10 turns
Front cover for separate display unit	81446858-001	Mask (1): PC/ABS, dark gray Plate (1): SPCC t1, black Mounting screws (2): M4 cross-recessed pan head machine screws, 7.5 mm long

● **Cover (No. 81446858-001) for separate display**

(Unit: mm)

Mask matl.: PC/ABS  
Color: Dark gray

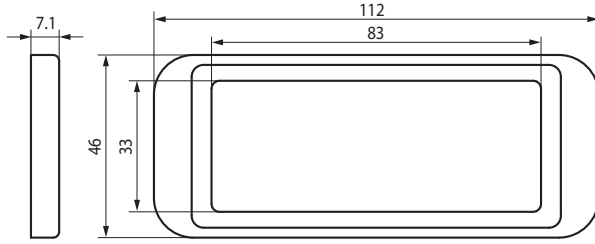
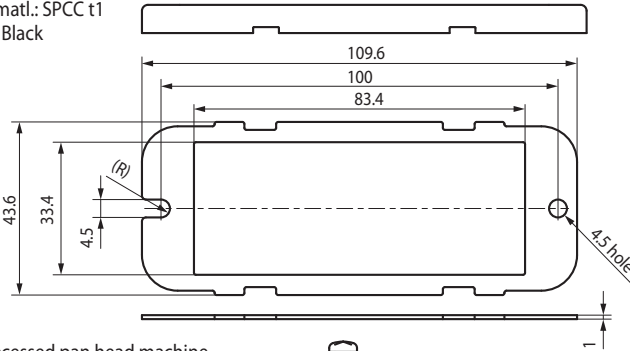

Plate matl.: SPCC t1  
Color: Black



M4 cross-recessed pan head machine screws for mounting (2), 7.5 mm long



● **Dedicated cable with connector**

• 20-wire flat cable (No. 81446681-001)

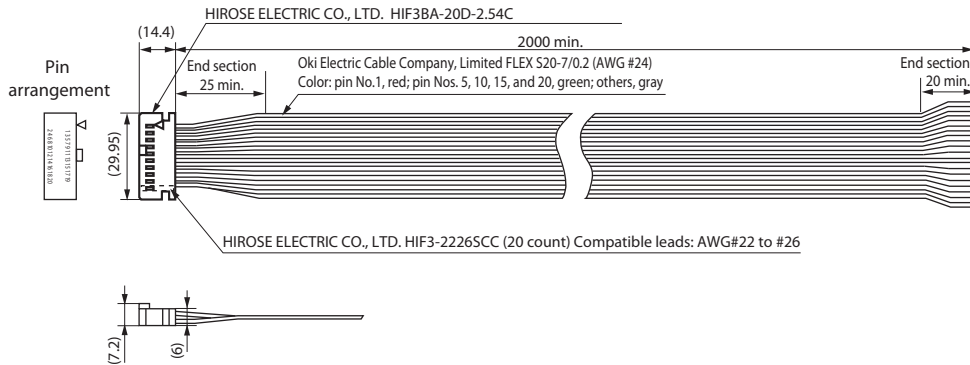

• 20-wire shielded cable (No. 81446951-001))

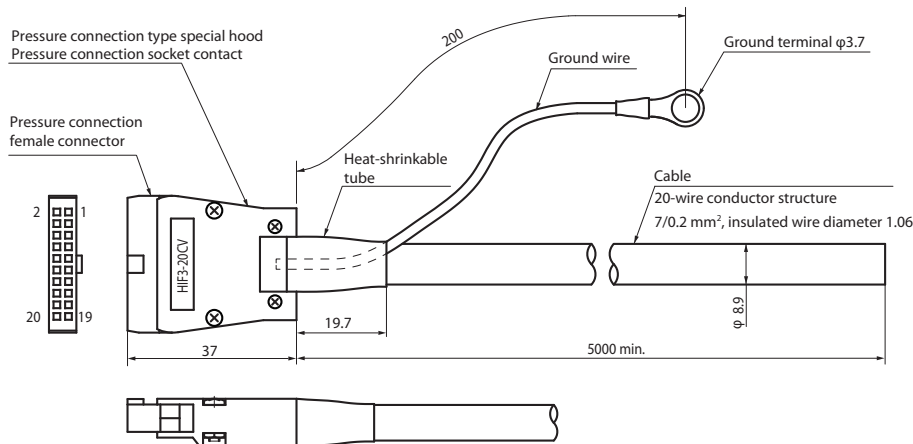

Pin number	Lead wire
1	Black
2	Black/White
3	Red
4	Red/White
5	Green
6	Green/White
7	Yellow
8	Yellow/White
9	Brown
10	Brown/White
11	Blue
12	Blue/White
13	Gray
14	Gray/White
15	Orange
16	Orange/White
17	Purple
18	Purple/White
19	Bright Green
20	Bright Green/White

● Potentiometer for flow rate setting (No. 81446683-002)

(Unit: mm)

• Digital dial

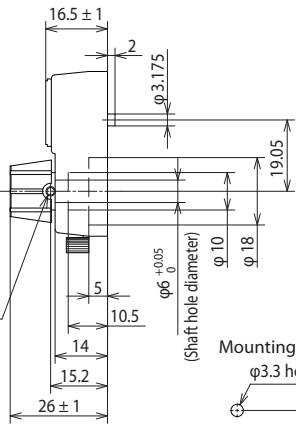
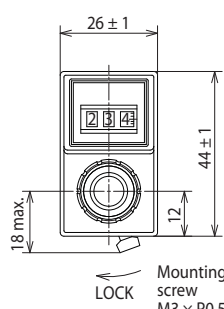

Mounting hole dimensions

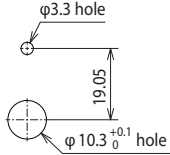

• Potentiometer

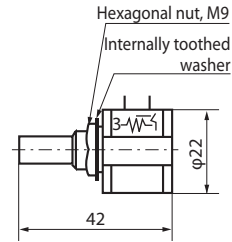
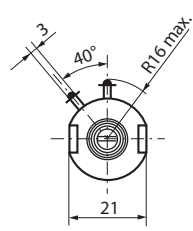

● AC adapter (No. 81446957-001)

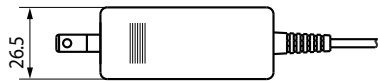
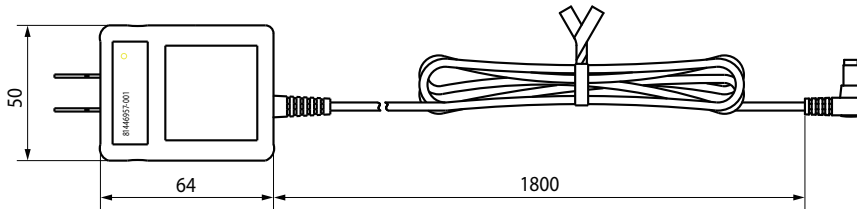

### Customer specifications check sheet for MQV models

Gas types	
Control flow range	Maximum_____ Normal_____ Minimum_____ L/min (normal)
Primary pressure	Maximum_____ Normal_____ Minimum_____ kPa (gauge)
Secondary pressure	Maximum_____ Normal_____ Minimum_____ kPa (gauge)
Fluid/ambient temperature range	Maximum_____ Normal_____ Minimum_____ °C
Connection method	<input type="checkbox"/> UNF <input type="checkbox"/> Rc <input type="checkbox"/> Swagelok <input type="checkbox"/> VCR
Display	<input type="checkbox"/> Integrated display unit <input type="checkbox"/> Separate display unit (with separate 2-m cable)
Communications	<input type="checkbox"/> With RS-485 <input type="checkbox"/> Without RS-485
Gas-contacting parts treated to be oil free	<input type="checkbox"/> Required <input type="checkbox"/> Not required
Traceability certificate / Inspection certificate	<input type="checkbox"/> Inspection Certificate <input type="checkbox"/> Traceability Certificate <input type="checkbox"/> Not required
Analog input/output	<input type="checkbox"/> 4-20 mA <input type="checkbox"/> 1-5 V <input type="checkbox"/> 0-5 V
Length of cables	<input type="checkbox"/> 2 m <input type="checkbox"/> 5 m <input type="checkbox"/> Other _____
Power supply	<input type="checkbox"/> 24 Vdc <input type="checkbox"/> 100 Vac (power outlet)
PC loader	<input type="checkbox"/> Required <input type="checkbox"/> Not required

**Flowmeter installation conditions**

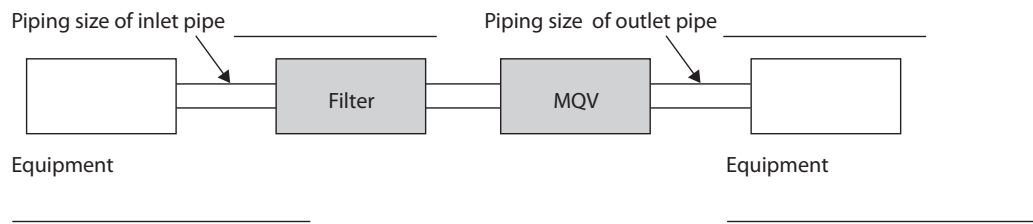

Allowable pressure loss for filter and flowmeter

\_\_\_\_\_ kPa (gauge)

Please read "Terms and Conditions" from the following URL  
before ordering and use.

<http://www.azbil.com/products/factory/order.html>

*Specifications are subject to change without notice.*

**azbil**

---

## Azbil Corporation

Advanced Automation Company

1-12-2 Kawana, Fujisawa  
Kanagawa 251-8522 Japan  
URL: <http://www.azbil.com/>

1st edition: Sep. 2012  
2nd edition: Oct. 2017

*No part of this publication may be reproduced or duplicated  
without the prior written permission of Azbil Corporation.*