

# Digital mass flow controller

## Semi-standard gas models

### Overview

The MQV series features high-performance digital mass flow controllers that incorporate a thermal mass flow sensor developed by Azbil Corporation, the  $\mu$ F (Micro Flow™) sensor, in addition to a proportional solenoid valve and advanced actuator control technology.

The semi-standard gas models can be used for acetylene and ammonia using an EPDM O-ring.

### Features

- 300 ms high-speed control.  
The ultra-high-speed response Micro Flow™ sensor and proprietary digital PID tuning deliver exceptionally high-speed performance in moving from a fully closed state to the set flow rate.  
MQV controllers also respond to changes in pressure on the primary side at high speed to minimize the effect on mass flow rates on the secondary side.
- The power circuit is isolated from analog I/O circuits. If multiple MQV controllers connected to analog I/Os by a PLC or the like, there is no need to use an isolated circuit in the analog module on the PLC side. A common power supply can be used to supply power to the MQV.
- MQV controller can operate at a low differential pressure of 50 kPa or even less.  
The MQV is suitable low-pressure control applications such as burner air-fuel ratio control.

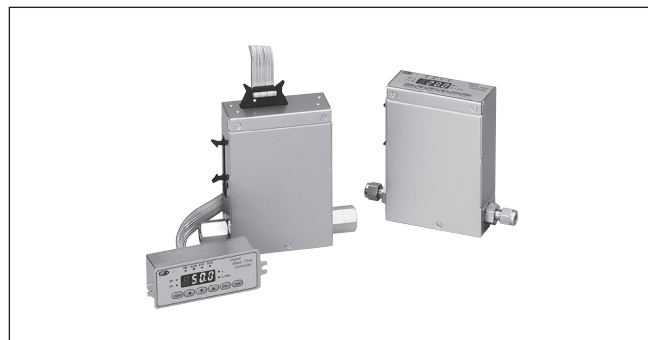

- MQV controllers offer a wide control range of 1 % FS to 100 % FS.
- Either an integrated display model or a separate display model can be selected according to the application needs.
- MQV controllers can be used over a wide operating temperature range (-10 °C to +60 °C).
- An AC adapter is also available that is suitable for use in a laboratory setting or similar application.

### Specifications

Item	Description								
	MQV9200	MQV9500	MQV0002	MQV0005	MQV0020	MQV0050(B,C)	MQV0200	MQV0500	
Valve type	Proportional solenoid valve								
Valve operation	Normally closed when de-energized (N.C.)								
Standard full scale (FS) flow rate *1	200 mL/min (standard)	0.500 L/min (standard)	2.00 L/min (standard)	5.00 L/min (standard)	20.0 L/min (standard)	50.0 L/min (standard)	200 L/min (standard)	500 L/min (standard)	
Gas type	Air/nitrogen (N <sub>2</sub> ), argon (Ar), carbon dioxide gas (CO <sub>2</sub> ), acetylene (C <sub>2</sub> H <sub>2</sub> ), ammonia (NH <sub>3</sub> ) *2 The gas must be dry and should not contain any corrosive components (chlorine, sulfur, acid). The gas must also be clean and not contain any dust or oil mist. The ammonia is to be a dry gas with a dew point of -20 °C max. *3								
Control	Range	1 % FS to 100 % FS (See Table 1 on page 4.)							
	Valve output update cycle	5 ms							
	Response (at standard differential pressure)	Within 0.3 s at setting $\pm$ 2 % FS (type)					Within 0.7 s at setting $\pm$ 2 % FS (type)		
	Accuracy (at the standard temperature and standard differential pressure, Q: flow rate) *4	$\pm$ 0.5 % FS (0 % FS $\leq$ Q $\leq$ 50 % FS) $\pm$ 1 % FS (50 % FS < Q $\leq$ 100 % FS)					$\pm$ 0.5 % FS (0 % FS $\leq$ Q $\leq$ 40 % FS) $\pm$ 1 % FS (40 % FS < Q $\leq$ 80 % FS) $\pm$ 1.5 % FS (80 % FS < Q $\leq$ 100 % FS)		

Item		Description							
		MQV9200	MQV9500	MQV0002	MQV0005	MQV0020	MQV0050(B,C)	MQV0200	MQV0500
Control	Repeatability	±0.25 % FS (0 % FS ≤ Q ≤ 50 % FS) ±0.5 % FS (50 % FS < Q ≤ 100 % FS)					±0.25 % FS (0 % FS ≤ Q ≤ 40 % FS) ±0.5 % FS (40 % FS < Q ≤ 80 % FS) ±0.75 % FS (80 % FS < Q ≤ 100 % FS)		
	Temperature characteristics	0.06 % FS max. per 1 °C *4				0.08 % FS max. per 1 °C			
	Pressure characteristics	0.2 % FS max. per 100 kPa *4			0.4 % FS max. per 100 kPa	0.2 % FS max. per 100 kPa			
Pressure	Standard differential pressure	200 kPa (Inlet pressure = 200 kPa (gauge), outlet pressure = 0 kPa (gauge))			150 kPa (Inlet pressure = 150 kPa (gauge), outlet pressure = 0 kPa (gauge))	200 kPa (Inlet pressure = 200 kPa (gauge), outlet pressure = 0 kPa (gauge))			
	Required differential pressure *5	50 kPa	5 kPa	50 kPa	5 kPa	50 kPa	100 kPa		150 kPa
	Operating differential pressure range	300 kPa max.					(1) 300 kPa max. (-10 °C ≤ T ≤ 40 °C) (2) 180 kPa max. (40 °C < T ≤ 60 °C)		(1) 300 kPa max. (-10 °C ≤ T ≤ 35 °C) (2) 240 kPa max. (35 °C < T ≤ 50 °C)
		(Condition: Power supply voltage = 24.0 V) *8							
	Allowable inlet pressure	-0.07 to 0.5 MPa [gauge] *6							
	Pressure resistance	1 MPa [gauge]							
Temperature	Standard operating temperature	+23 °C							
	Allowable operating temperature range	-10 to +60 °C						-10 to 50 °C	
	Allowable storage temperature range	-20 to +70 °C							
Humidity	Allowable operating humidity range	10 to 90 % RH (without condensation)							
External leaks	Helium leak rate	1×10 <sup>-6</sup> Pa·m <sup>3</sup> /s max. (with VCR connection only)							
Flow rate setup	Setup method	(1) Key operation, (2) External analog input, (3) Dedicated loader communications *8, (4) RS-485 communications (3-wire system) *9							
	Setup resolution	See Table 1 on page 4.							
	External analog input	Input range: 0 to 5 Vdc/1 to 5 Vdc/0 to 20 mA/4 to 20 mA (switchable) Input impedance: Voltage input type: 1 MΩ ± 10 %, Current input type: 250 Ω ± 10 %							
Flow rate display	Display method	7-segment LED, 4 digits							
	Display resolution	See Table 1 on page 4.							
	Indication accuracy (at the standard temperature and standard differential pressure, Q: flow rate)	± 0.5 % FS ± 1 digit (0 % FS ≤ Q ≤ 50 % FS) ± 1 % FS ± 1 digit (50 % FS < Q ≤ 100 % FS)					± 0.5 % FS ± 1 digit (0 % FS ≤ Q ≤ 40 % FS) ± 1.0 % FS ± 1 digit (40 % FS < Q ≤ 80 % FS) ± 1.5 % FS ± 1 digit (80 % FS < Q ≤ 100 % FS)		
Totalizing function	Display range	0.00 to 999,999.99 L	0.00 to 999,999.99 L	0.0 to 9,999,999.9 L	0.0 to 9,999,999.9 L	0 to 99,999,999 L	0 to 99,999,999 L	0.00 to 999,999.99 m <sup>3</sup>	0.00 to 999,999.99 m <sup>3</sup>
	Display resolution	0.01 L	0.01 L	0.1 L	0.1 L	1 L	1 L	0.01 m <sup>3</sup>	0.01 m <sup>3</sup>
	Totalized count backup timing	(1) 2 L per count	(1) 5 L per count	(1) 20 L per count	(1) 50 L per count	(1) 200 L per count	(1) 500 L per count	(1) 2 m <sup>3</sup> per count	(1) 5 m <sup>3</sup> per count
		(2) Once per hour after the previous backup, (3) At the time that the RUN key is pressed.							
Analog output	Output type	Instantaneous flow rate (PV) output or setting flow rate (SP) output (switchable)							
	Output scale	0 to full-scale flow rate (scale can be changed)							
	Output range	0 to 5 Vdc/1 to 5 Vdc/0 to 20 mA/4 to 20 mA (switchable)							
	Max. output	7 Vdc or 28 mA max. (output when flow rate exceeds the range)							
	Accuracy	Total output accuracy ± 0.3 % FS, indication accuracy ± 0.3 % FS							
	External resistance	Voltage output type: 250 kΩ min., current output type: 300 Ω max.							
Alarm/event output	Number of outputs	Alarm output: 1, Event output: 2							
	Output rating	30 Vdc, 30 mA max. (Non-isolated open collector output)							
	Totalized pulse output width	100 ms ± 10 % (when pulse output is selected in the function setup)							
	Totalized pulse output rate	0.01 L/pulse		0.1 L/pulse		1 L/pulse		0.01 m <sup>3</sup> /pulse	
External switching Input	Input type, number of inputs	External 3-way switching input: 1 External contact input (2-way switching): 3							
	Required circuit type	Non-voltage contacts or open collector							
	Contact OFF terminal voltage	External 3-way switching input: 2.5 ± 0.5 V, External contact input: 2.8 ± 0.5 V							
	Contact ON terminal current	Approx. 0.5 mA (current flowing to contact)							
	Allowable ON contact resistance	250 Ω max.							
	Allowable OFF contact resistance	100 kΩ min.							
	Allowable ON residual voltage	1.0 V max. (open collector type)							
Allowable OFF leakage current	50 μA max. (open collector type)								

Item		Description							
		MQV9200	MQV9500	MQV0002	MQV0005	MQV0020	MQV0050(B,C)	MQV0200	MQV0500
Reference voltage output	Output rating	5.0 Vdc $\pm$ 5 %, 5 mA max.							
	Application	Reference voltage for flow rate set voltage and for 5 V input of external 3-way switching input							
Communications	Mode	(1) Dedicated loader communications <sup>*8</sup> , (2) RS-485 communications (3-wire system) <sup>*9</sup>							
	Transmission speed	2400, 4800, 9600, 19200, 38400 bps (19200 bps: loader communication only)							
Power supply	Rating	24 Vdc, current consumption: 300 mA max.				24 Vdc, current consumption: 400 mA max.		24 Vdc, current consumption: 500 mA max.	
	Allowable power voltage range	21.6 to 26.4 Vdc				(1) 21.6 to 26.4 Vdc (-10 °C $\leq$ T $\leq$ 40 °C) (2) 23.5 to 26.4 Vdc (40 °C < T $\leq$ 60 °C)		(1) 21.6 to 26.4 Vdc (-10 °C $\leq$ T $\leq$ 35 °C) (2) 23.5 to 26.4 Vdc (35 °C < T $\leq$ 50 °C)	
		(ripple 5 % max.)							
	Isolation	The power circuit is isolated from the input/output circuit.							
Materials used in gas-contacting parts	SUS316, polytetrafluoroethylene (PTFE), ethylene propylene diene Monomer (EPDM)								
Connection method	1/4" Rc, 1/4" Swagelok, 1/4" VCR					1/2" Swagelok			
Mounting orientation	Horizontal. Be sure that display surface does not face down.								
Mass	Approx. 1.2 kg					Approx. 3.5 kg			
Applicable standards	EN61326-1:2013 EN61326-2-3:2013								

Notes:

- \*1. mL/min and L/min (standard) indicate the volumetric flow rate per minute (mL/min and L/min) converted to conditions of 20 °C and 101.325 kPa (1 atm). The reference temperature can be changed to 0 °C, 25 °C, or 35 °C. The controllable flow rate range, which is the value for air/nitrogen, varies depending on the gas type. See Table 1 on page 4.
- \*2. Do not use this product with any gas other than those listed. An EPDM O-ring is used in the seals of this product, and if the product is used with any other gas, the O-ring sealing characteristics may be damaged.
- \*3. Prevent foreign matter from entering the device. If rust, water droplets, oil mist, or dust in the pipes enter the device, measurement or control error or damage might occur.  
If there is a possibility of foreign matter entering the device, provide a filter, strainer or mist trap capable of eliminating foreign matter 0.1  $\mu$ m or greater in diameter on the upstream side. Be sure to inspect and replace the filter at regular intervals.
- \*4. For air/nitrogen.
- \*5. Differential pressure required for obtaining full-scale flow rate. (Outlet pressure = 0 kPa (gauge).)  
Operation is possible even below the required differential pressure, but the controllable flow rate range becomes narrower. See the graphs for differential pressure vs. flow rate on page 5.
- \*6. For information on the advisability of using an inlet pressure greater than 0.5 MPa (gauge), contact the azbil Group.
- \*7. The maximum operating differential pressure for the MQV0200/0500 may vary according to the power supply voltage. See the graphs for power supply voltage vs. maximum operating differential pressure on page 6.
- \*8. Requires a dedicated loader package (MLP100A100), sold separately.
- \*9. Only models with the RS-485 communications option.

Functions

Function	Description
Flow rate totalization	Integrated flow count can be up to eight digits long (to 99,999,999) for each unit. (For display resolutions, see specification table.)
Alarm lamp/output/blocking	An upper/lower limit flow rate alarm and a valve drive current alarm can be set to respond to deviation of the instantaneous flow rate from the set flow rate. The valve can be forcibly opened/closed during an alarm.
OK lamp	The OK lamp can be set to light when the control flow rate is within the set value $\pm$ allowable range.
Event lamp/event output	<ul style="list-style-type: none"> <li>• Integrated flow event output</li> <li>• Totalized pulse output rate</li> <li>• OK output</li> <li>• Output mode</li> </ul> Two of the event types listed above can be selected.
Automatic shut-off	The valve can be shut off automatically under the following conditions: <ul style="list-style-type: none"> <li>• When the totalized flow count reaches the preset value.</li> <li>• When one of the alarms, including flow rate alarms, is triggered.</li> </ul> <b>Note:</b> The valve on this device cannot completely shut off a flow.
Automatic reset of totalized flow count at start of control	This function can be used to reset the cumulative count simultaneously with the start of control operation using key operation or external contact input.
Valve forcibly open or close	This function can be used to fully open/close the valve using key operation or external contact input.
Multi-setup	Quickly switch to one of eight preset flow values by key operation or external input.
Direct setup function	Settings can be changed with just the $\blacktriangle$ and $\blacktriangledown$ keys instead of a complex operation process.
Full multi-range setup	The control range can be set freely from 100 % down to 10 % of the standard range in 1 % FS increments. The control range can be set freely according to the application. Additionally, two preset control flow ranges can be switched by external contact input. This function can also be used to change the resolution setting.
Slow start	Sudden changes in the controlled flow rate, when control is started or when the set value is changed, can be suppressed.
Gas type switching	The gas type to be used can be selected from the standard compatible gases by key operation. Additionally, two preset gas type settings can be changed by external contact input.
Gas type setup	The user can set gas type conversion factors for gases other than the standard compatible gases, and for mixed gases.
SP ramp control	Two SP change rates (gradients) can be specified at the start of control operation or when changing settings. Also, an external switch can be connected to the device and used to switch the rate.
Valve driving current alarm function	This function monitors the amount of current driving the proportional valve and outputs an alarm under certain conditions. <b>Note:</b> when setting the alarm, that the amount of differential pressure and other factors may cause fluctuations in the valve drive current even if the set flow rate is uniform.
Loader communications	A communications port for loader communications is included as standard equipment. The dedicated loader package (MLP100A100), sold separately, enables one-to-one serial communication with a PC. (Various types of settings and monitor display settings can be completed on the PC display screen.)
RS-485 communication (option)	Three-wire RS-485 communication is also available as an option. (Transmission speed: 2400 bps to 38400 bps)

Table 1. Control flow rate range and setup/display resolution (For MQV9200: mL/min (standard), for all other models: L/min (standard))

Gas types	MQV9200		MQV9500		MQV0002		MQV0005	
	Control flow rate range	Setup/display resolution *2	Control flow rate range	Setup/display resolution *2	Control flow rate range	Setup/display resolution *2	Control flow rate range	Setup/display resolution *2
Air/nitrogen	2 to 200	1	0.004 to 0.500	0.002	0.02 to 2.00	0.01	0.04 to 5.00	0.02
Oxygen	2 to 200	1	0.004 to 0.500	0.002	0.02 to 2.00	0.01	0.04 to 5.00	0.02
Argon	2 to 200	1	0.004 to 0.500	0.002	0.02 to 2.00	0.01	0.04 to 5.00	0.02
Carbon dioxide	1.0 to 120.0	0.5	0.003 to 0.300	0.001	0.010 to 1.200	0.005	0.03 to 3.00	0.01
Acetylene (C <sub>2</sub> H <sub>2</sub> ) *1	1.0 to 120.0	0.5	0.003 to 0.300	0.001	0.010 to 1.200	0.005	0.03 to 3.00	0.01
Ammonia (NH <sub>3</sub> ) *1	2 to 160	1	0.004 to 0.400	0.002	0.02 to 1.60	0.01	0.04 to 4.00	0.02

Gas types	MQV0020		MQV0050 (B,C)		MQV0200		MQV0500	
	Control flow rate range	Setup/display resolution *2	Control flow rate range	Setup/display resolution *2	Control flow rate range	Setup/display resolution *2	Control flow rate range	Setup/display resolution *2
Air/nitrogen	0.2 to 20.0	0.1	0.4 to 50.0	0.2	2 to 200	1	4 to 500	2
Oxygen	0.2 to 20.0	0.1	0.4 to 50.0	0.2	2 to 200	1	4 to 500	2
Argon	0.2 to 20.0	0.1	0.4 to 50.0	0.2	2 to 200	1	4 to 500	2
Carbon dioxide	0.10 to 12.00	0.05	0.3 to 30.0	0.1	1 to 120	0.5	4 to 400	2
Acetylene (C <sub>2</sub> H <sub>2</sub> ) *1	0.10 to 12.00	0.05	0.3 to 30.00	0.1	1.0 to 120.0	0.5	4 to 400	2
Ammonia (NH <sub>3</sub> ) *1	0.2 to 16.0	0.1	0.4 to 40.0	0.2	2 to 160	1	4 to 400	2

\*1. The values given for acetylene and ammonia are estimated values based on the physical properties of the gases, so their accuracy is not guaranteed. However, the values given for repeatability are fully applicable to these two gases.

For use in applications that require high flow rate accuracy, this device should be used only after careful verification of the conversion factor (CF).

\*2. Contact the azbil Group for assistance with input of settings and output of flow rate with analog signals, as this will help increase resolution dramatically.

**Relationship of differential pressure and flow rate with valve fully open (for air)**

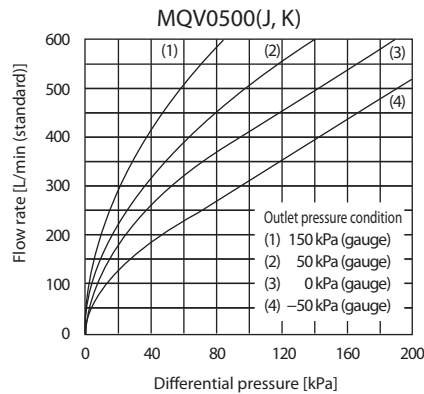
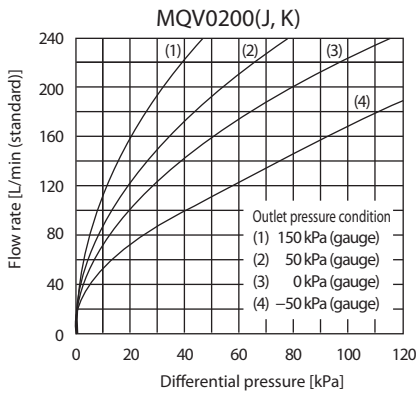
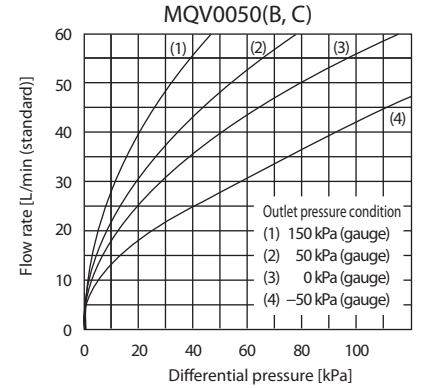
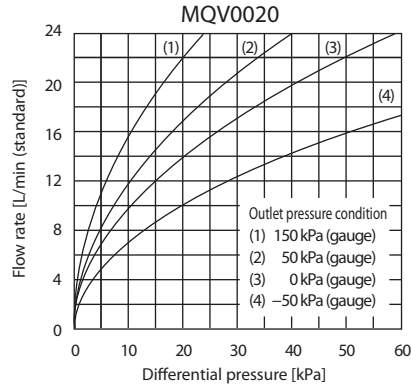
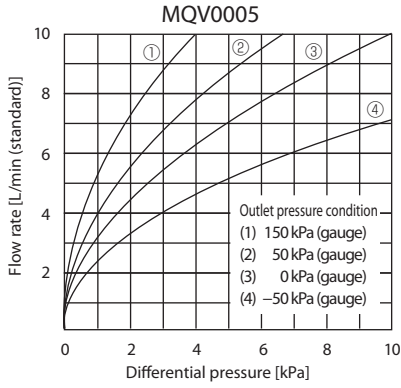
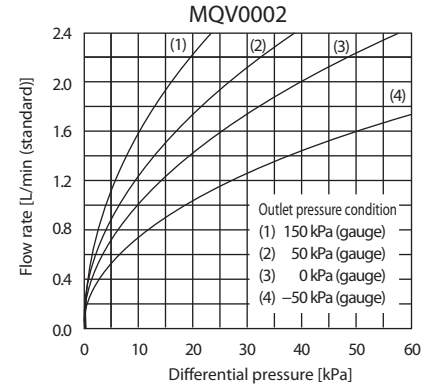
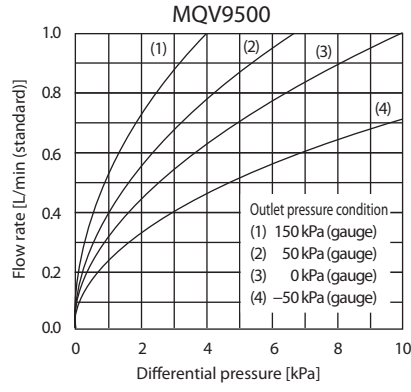
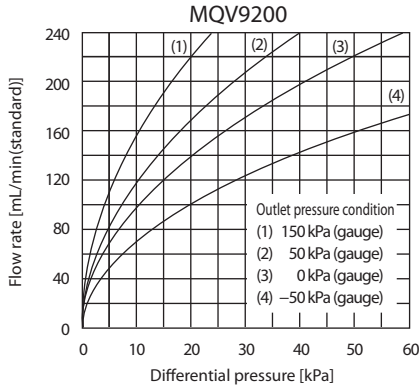

## ! Handling Precautions

- If the outlet pressure is different from the values graphed on the previous page, calculate the flow rate using the appropriate equation below.

- (1) When  $P_2 / P_1 > 0.53$ ,  $P_1$ : Inlet absolute pressure [kPa (abs)]  
 $Q = C_1 \sqrt{(P_1 - P_2)P_2}$   $P_2$ : Outlet absolute pressure [kPa (abs)] (Absolute pressure = gauge pressure + 101.3 kPa)
- (2) When  $P_2 / P_1 \leq 0.53$ ,  $Q$ : Flow rate [L/min (standard)]  
 $Q = C_2 \cdot P_1$  ([mL/min (standard)] for MQV9200)

$C_1, C_2$ : Constant values by model

- (1) MQV9200:  $C_1 = 3.123, C_2 = 1.559$   
 (2) MQV9500:  $C_1 = 0.03123, C_2 = 0.01559$   
 (3) MQV0002:  $C_1 = 0.03123, C_2 = 0.01559$   
 (4) MQV0005:  $C_1 = 0.3123, C_2 = 0.1559$   
 (5) MQV0020:  $C_1 = 0.3123, C_2 = 0.1559$   
 (6) MQV0050B/C:  $C_1 = 0.5529, C_2 = 0.2760$   
 (7) MQV0200J/K:  $C_1 = 2.212, C_2 = 1.104$   
 (8) MQV0500J/K:  $C_1 = 4.115, C_2 = 2.054$

Specific gravity of standard compatible gas  
 (That for air is taken to be 1.0)

Gas type	Specific gravity
Oxygen	1.11
Argon	1.38
Carbon dioxide	1.53
Acetylene	0.91
Ammonia	0.60

- When used with the gases other than air, convert the flow rate using the following equation:

$$\text{Flow rate} = \text{Flow rate in air} \div \sqrt{\text{specific gravity of gas to be controlled}}$$

Example: When using the MQV0002 with CO<sub>2</sub>, inlet pressure = 10 kPa (gauge),  
 and outlet pressure = 0 kPa (gauge)

## Differential pressure vs. flow rate output for the MQV0500 with the valve fully closed (for air under conditions where the outlet pressure = 0 kPa (gauge))

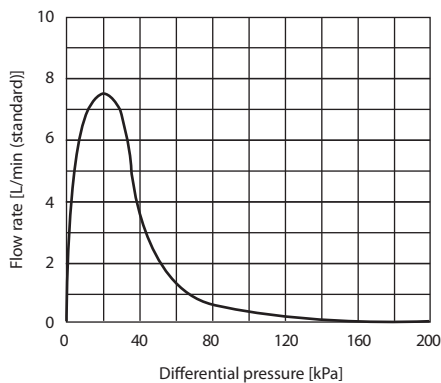

## Power supply voltage vs. maximum operating differential pressure for MQV0200/0500

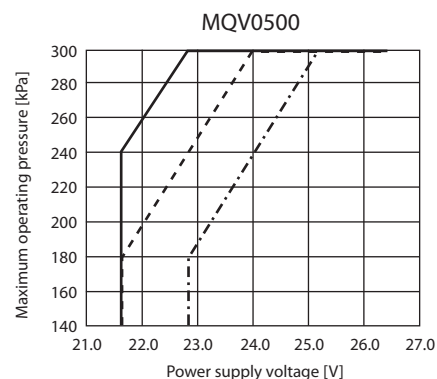
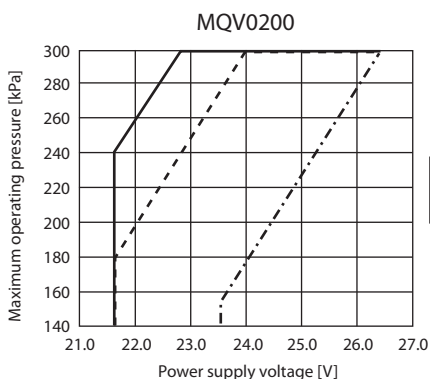

## ! Handling Precautions

- If this device is operated with a differential pressure exceeding the maximum operating differential pressure shown in the graph on the preceding page, the voltage to the valve becomes insufficient and the target flow rate cannot be obtained. Additionally, even if the voltage does not become insufficient, flow rate hunting may occur if the operating differential pressure exceeds 300kPa. Always operate this device with a differential pressure less than 300kPa.

# Wiring

## Connector pin layout



View from connector insertion side

Connector model No. (device side): HIF3BA-20PA-2.54DS (manufacturer: HIROSE ELECTRIC CO., LTD.)

Table of compatible connectors

Connector type	Compatible connector model No.	Compatible contact model No.	Compatible leads
Contact crimp type	HIF3BA-20D-2.54C	HIF3-2226SCC	AWG#22 to #26 (individual wires OK)
Cable clamp type	HIF3BA-20D-2.54R	Not required	AWG#28 (flat cable only)

## Connector signal names

Pin number	Signal name	Description	Remarks
20	+5 V (5 mA max.)	5 Vdc reference voltage output	5 mA max.
19	FLOW OUT	Instantaneous flow rate (PV) or flow rate set point (SP) output	0 to 5 V/1 to 5 V/0 to 20 mA/4 to 20 mA output
18	A.GND	Analog ground	Analog signal common
17	FLOW SP INPUT	Set point flow rate (SP) voltage input	0 to 5 V/1 to 5 V/0 to 20 mA/4 to 20 mA input
16	MODE INPUT	External 3-way switching	3-stage switching input (OPEN/GND/5 V)
15	DI3	External contact input 3	2-stage switching input (OPEN/GND)
14	DI2	External contact input 2	
13	DI1	External contact input 1	
12	EV2 OUT	Event output 2	Open collector non-isolated output
11	EV1 OUT	Event output 1	
10	ALM OUT	Alarm output	
9	D.GND	Digital ground	Digital signal common
8	DB	RS-485 communications DB	Do not connect on models without the communications function.
7	DA	RS-485 communications DA	
6	D.GND	Digital ground	Digital signal common
5	TEST	For test	Do not use
4	POWER GND	Power supply ground	Connect two wires each in parallel to the power supply to reduce voltage drop caused by wiring resistance.
3	POWER GND	Power supply ground	
2	POWER (24 V)	Power supply + (24 Vdc)	
1	POWER (24 V)	Power supply + (24 Vdc)	

## Example of wiring

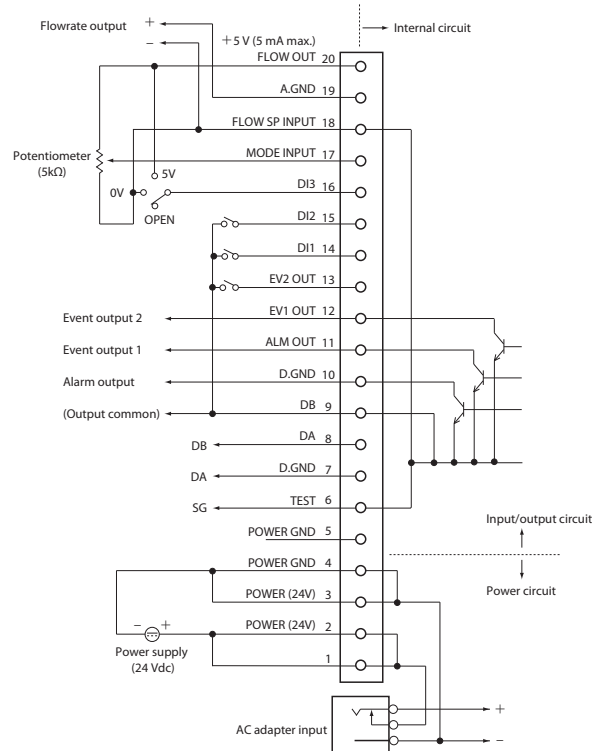

- Do not input any signal to pin No. 5.
- The power circuit is isolated from the Input/output circuit inside this device.
- Even though the analog GND and digital GND are connected internally, always carry out the grounding wiring individually.
- When the AC adapter plug is inserted into the AC adapter power supply terminal, the power supply changes from the DC power supply to the AC adapter.
- The previous AC adapter, No. 81446682-001 (15 Vdc, 350 mA), cannot be used with this MQV.

\*1. Analog I/O

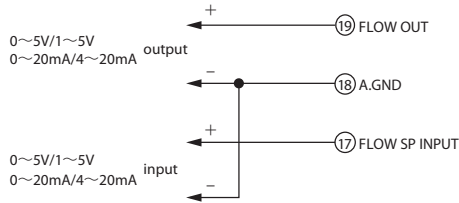

\*2. External 3-way switching input

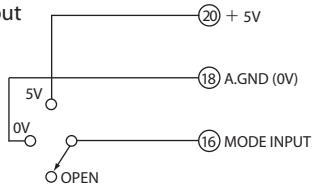

**!** Handling Precautions

- When switching by relay, use an appropriate relay intended for microcurrent use (with gold contacts). Failure to do so could cause faulty contact, resulting in malfunction.

Operation of external 3-way switching input

Assigned function		Input state of pin No.16		
		OPEN	0V	5V
Switching of operating mode 1		Control	Fully closed	Fully open
Switching of SP No.		SP-0	SP-1	SP-2
Switching of totalizing operation		Continue counting	Reset	Stop counting
Analog input/output I/O voltage range	Input	Internal reference 0 to 5 V * or external reference 0 to 20 mA	External reference 0 to 5 V/0 to 20 mA	External reference 1 to 5 V/4 to 20 mA
	output	0 to 5 V/0 to 20 mA	0 to 5 V/0 to 20 mA	1 to 5 V/4 to 20 mA
Switching of operating mode 2		Fully closed	Control	Fully open

\* "Internal reference" refers to the use of the 5 Vdc reference voltage pin (No. 20) on this device, and is used when the setting value is set by an externally connected potentiometer.

\* 3. When using a potentiometer (0 to 5 V)

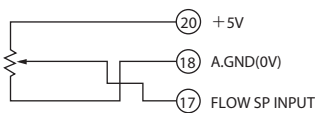



## Model selection guide

### ■ Semi-standard gas, low flow rate models

Basic model No.	Control flow rate range	Display	Body material	Connection method	Gas type	Optional function 1	Optional function 2	Optional function 3	Optional function 4	Optional function 5	Appended No.	Description
MQV												Digital mass flow controller, MQV series
	9200											2 to 200 mL/min (standard) *1, *3
	9500											0.004 to 0.500 L/min (standard) *1, *3
	0002											0.02 to 2.00 L/min (standard) *1, *3
	0005											0.04 to 5.00 L/min (standard) *1, *3
	0020											0.2 to 20.0 L/min (standard) *1, *3
	0050											0.4 to 50.0 L/min (standard) *1, *3
		B										Integrated display (body length: 90 mm)
		C										Separate display (body length: 90 mm)
			S									SUS316
				R								1/4" Rc
				S								1/4" Swagelok
				V								1/4" VCR
					E							Semi-standard gas *2
						0						Without optional functions
							0					Without optional functions
							1					Model with RS-485 communications (CPL) function
								0				Without optional functions
									1			Gas-contacting parts treated to be oil free
										0		Without optional functions
										D		With inspection certificate
										Y		With traceability certificate
											0	Product version

### ■ Semi-standard gas, medium flow rate models

Basic model No.	Control flow rate range	Display	Body material	Connection method	Gas type	Optional function 1	Optional function 2	Optional function 3	Optional function 4	Optional function 5	Appended No.	Description
MQV												Digital mass flow controller, MQV series
	0200											2 to 200 L/min (standard) *1, *3
	0500											4 to 500 L/min (standard) *1, *3
		J										Integrated display (body length: 150 mm)
		K										Separate display (body length: 150 mm)
			S									SUS316
				S								1/2" Swagelok
					E							Semi-standard gas *2
						0						Without optional functions
							0					Without optional functions
							1					Model with RS-485 communications (CPL) function
								0				Without optional functions
									1			Gas-contacting parts treated to be oil free
										0		Without optional functions
										D		With inspection certificate
										Y		With traceability certificate
											0	Product version

#### Notes:

\*1. mL/min (standard) and L/min (standard) indicate the volumetric flow rate per minute (mL/min and L/min) converted to conditions of 20 °C and 101.325 kPa (1 atm). The reference temperature can be changed to 0, 25, or 35 °C.

\*2. The MQV is initially set for air/nitrogen use before shipment from the factory. However, the gas type can be changed to argon, carbon dioxide (CO<sub>2</sub>), acetylene (C<sub>2</sub>H<sub>2</sub>), ammonia (NH<sub>3</sub>).

\*3. The controllable flow rate range varies depending on the gas type. See table 1. "Control flow rate range and setup/display resolution".

# External dimensions

## Models with integrated display

- Low flow rate models

(Unit: mm)

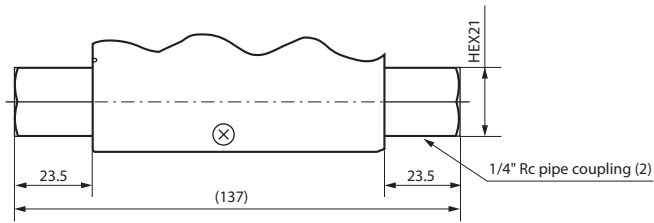
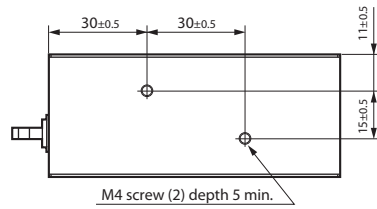
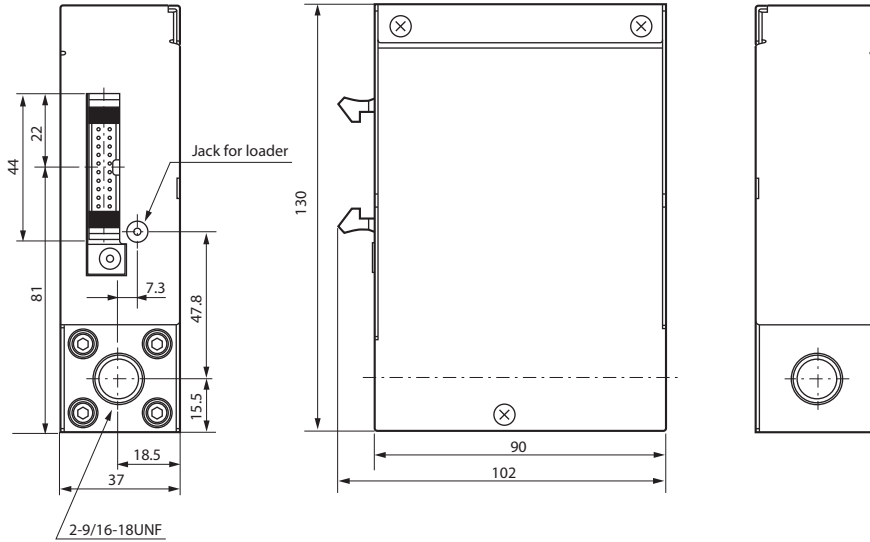
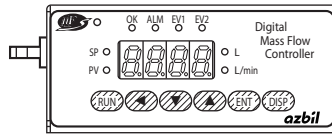

1/4" Rc connection type (option)

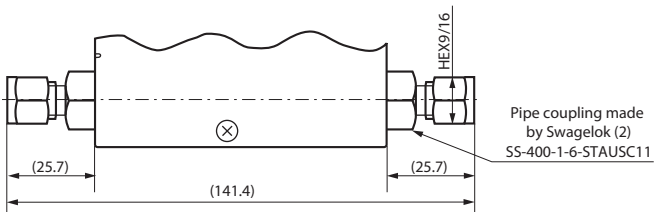

1/4" Swagelok connection type (option)

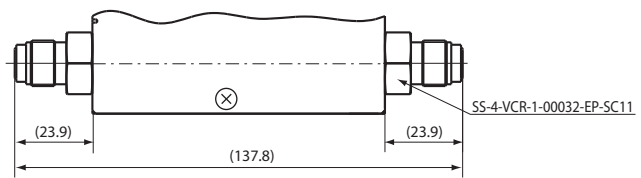

1/4" VCR connection type (option)

• Medium flow rate models

(Unit: mm)

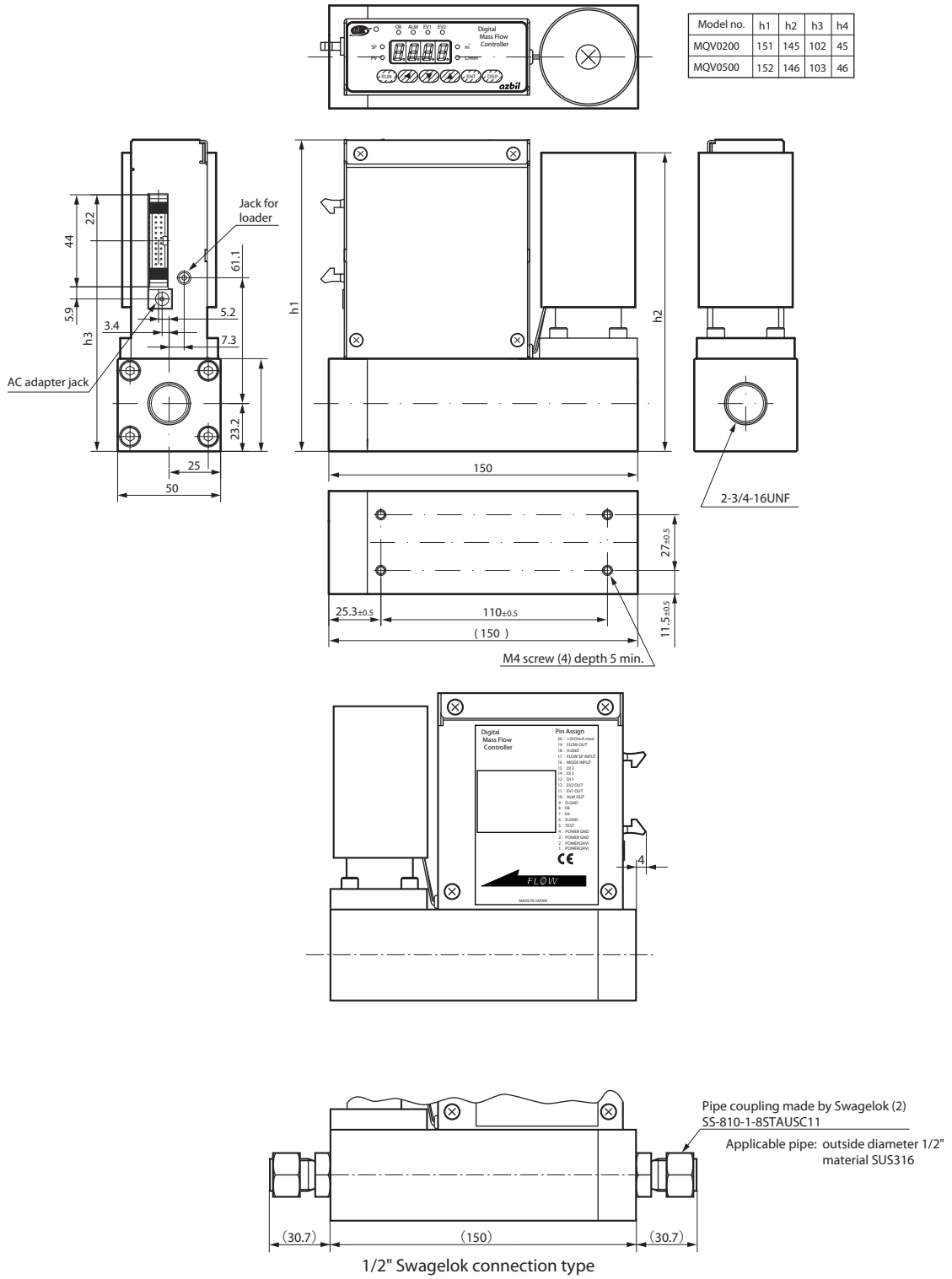

■ Model with separate display (main unit)

• Low flow rate models

(Unit: mm)

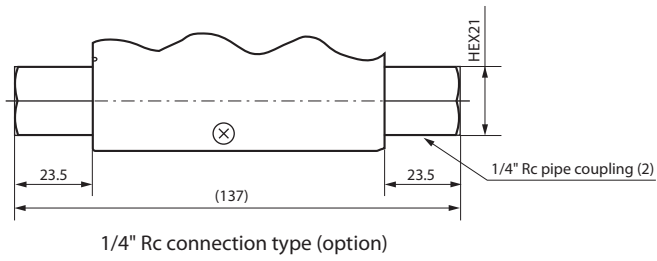
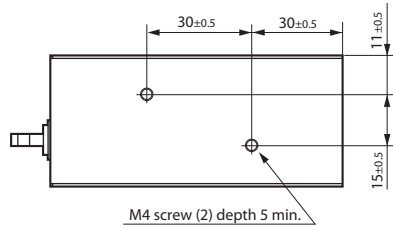
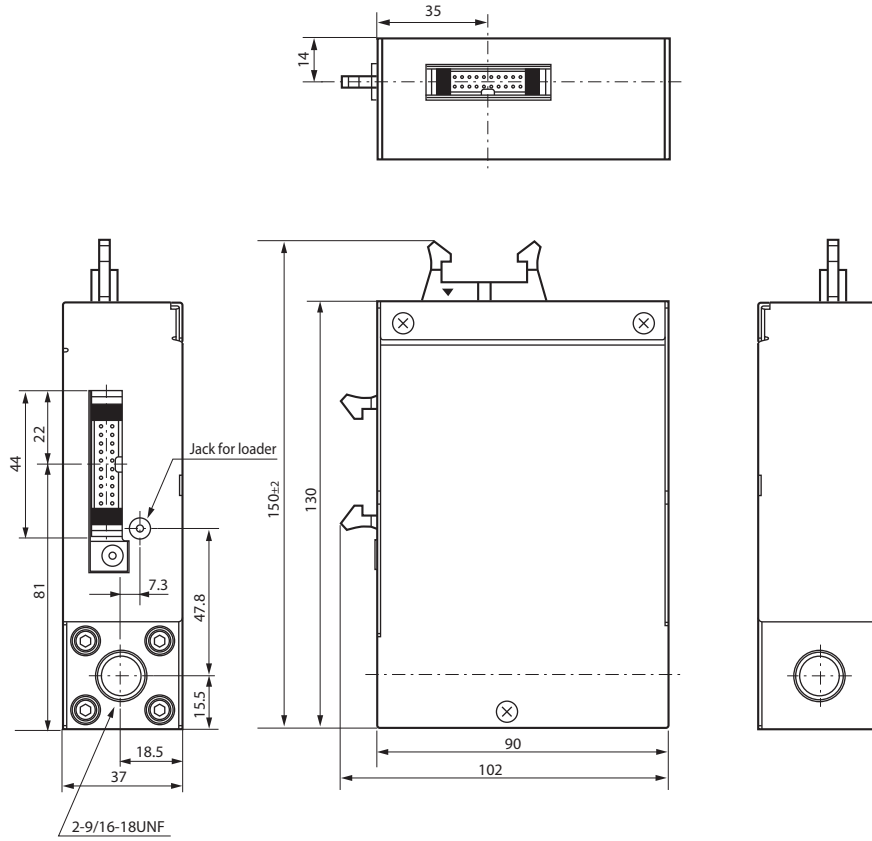

1/4" Rc connection type (option)

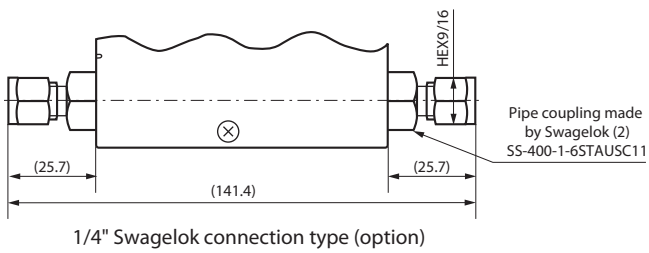

1/4" Swagelok connection type (option)

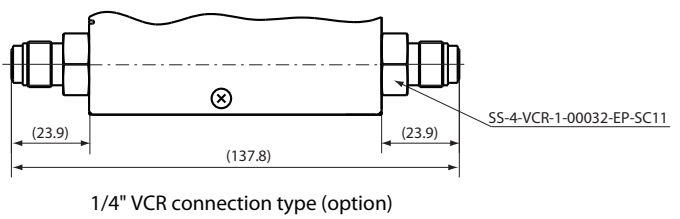

1/4" VCR connection type (option)

• Medium flow rate models

(Unit: mm)

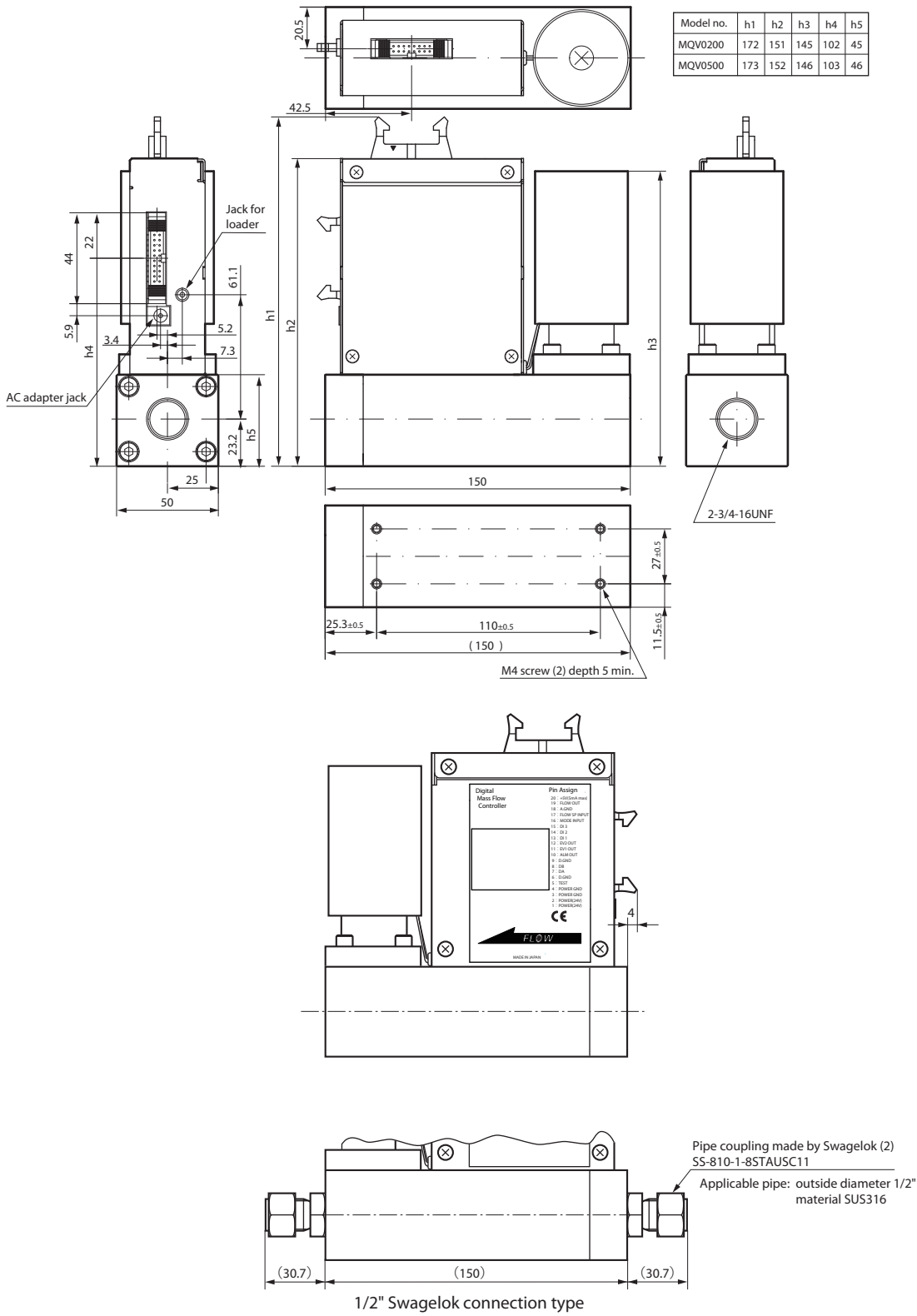

## ■ Model with separate display (display)

(Unit: mm)

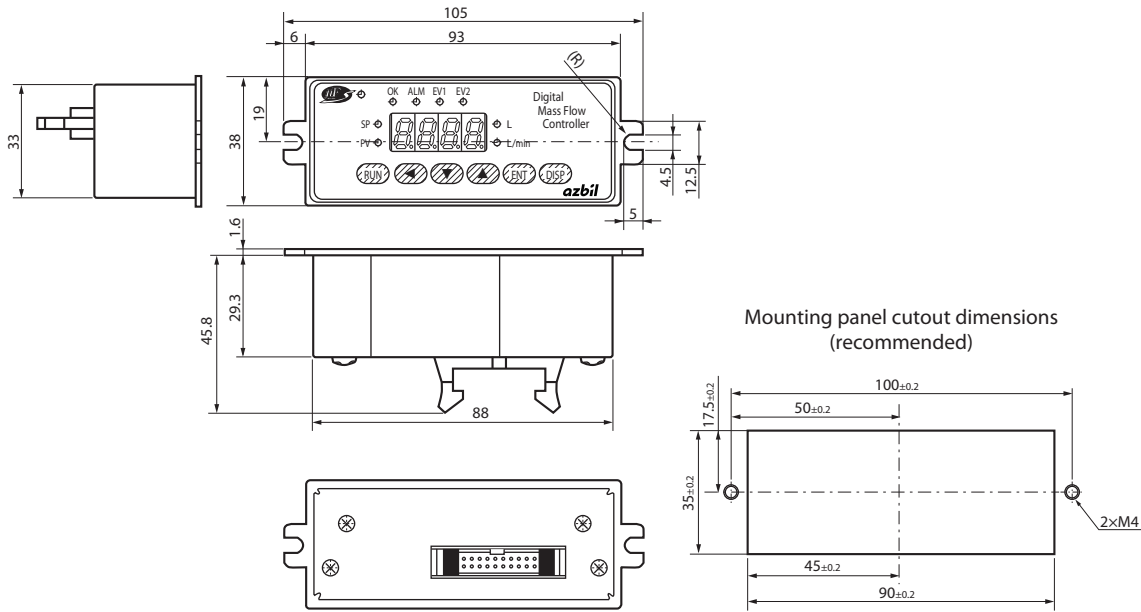

## ■ Cable for connecting display to main unit

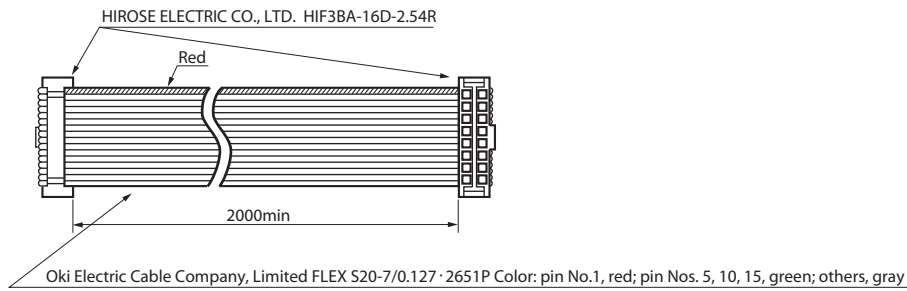

Table 2. Optional parts (sold separately)

Item	Model No.	Remarks
Dedicated cable with connector	81446681-001	20-wire flat cable, 2 m (AWG#24)
	81446951-001	20-wire shielded cable, 5 m
AC adapter	81446957-001	Rating Input rating: 100 to 240 Vac Output rating: 24 Vdc/750 mA Operating temperature range: 0 °C to 40 °C
Potentiometer for flow rate setting	81446683-002	5 kΩ with digital dial, 10 turns
Front cover for separate display unit	81446858-001	Mask (1): PC/ABS, dark gray Plate (1): SPCC t1, black Mounting screws (2): M4 cross-recessed pan head machine screws, 7.5 mm long

## ■ Cover (No. 81446858-001) for separate display

(Unit: mm)

Mask  
Material: PC/ABS  
Color: Dark gray

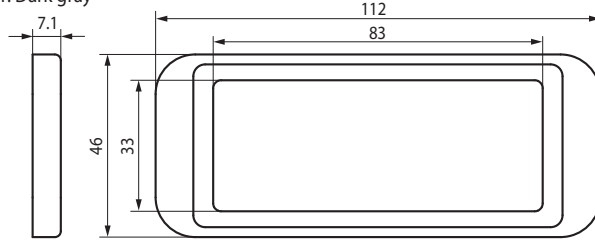
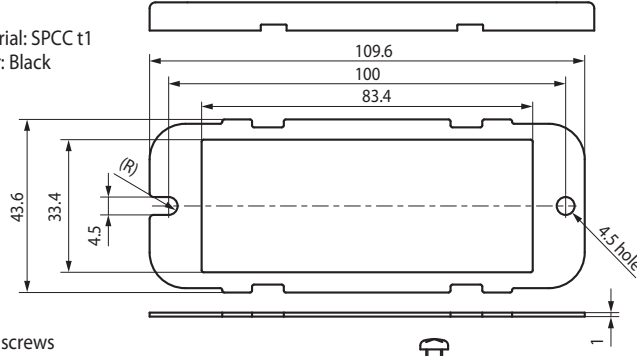

Plate  
Material: SPCC t1  
Color: Black



Mounting screws

(2): M4 cross-recessed pan head machine screws, 7.5 mm long

## ■ Dedicated cable with connector

### • 20-wire flat cable (No. 81446681-001)

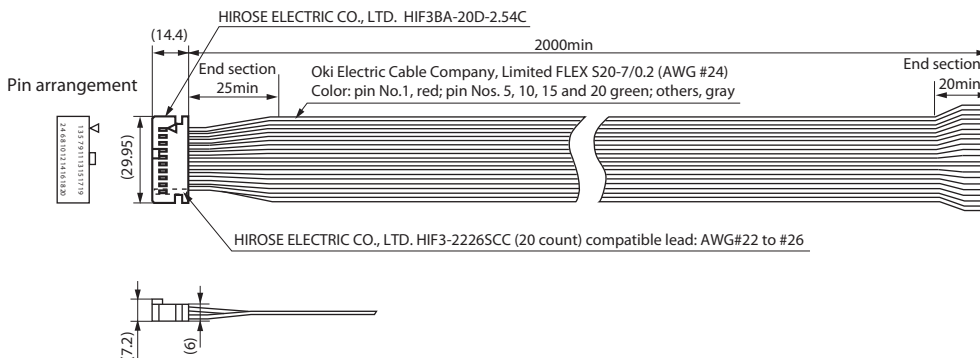

### • 20-wire shielded cable (No. 81446951-001)

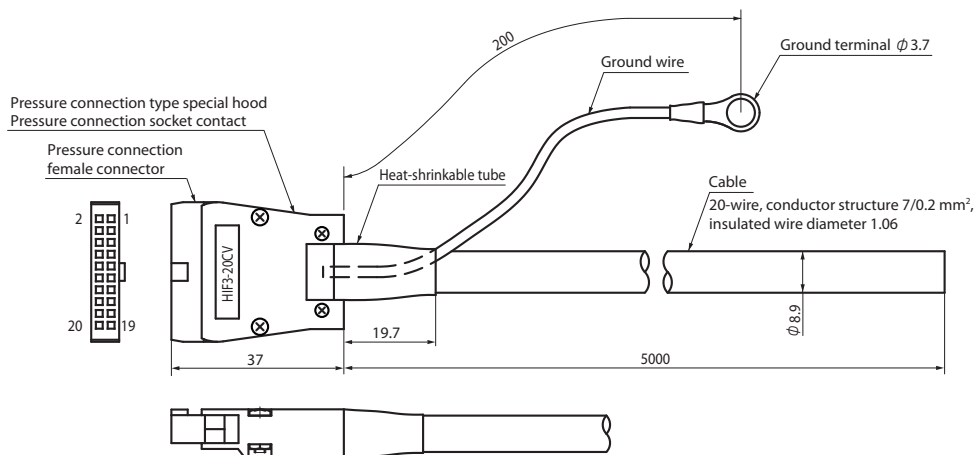

Pin number	Lead wire
1	Black
2	Black/White
3	Red
4	Red/White
5	Green
6	Green/White
7	Yellow
8	Yellow/White
9	Brown
10	Brown/White
11	Blue
12	Blue/White
13	Gray
14	Gray/White
15	Orange
16	Orange/White
17	Purple
18	Purple/White
19	Bright Green
20	Bright Green/White

■ Potentiometer for flow rate setting (No. 81446683-002)

(Unit: mm)

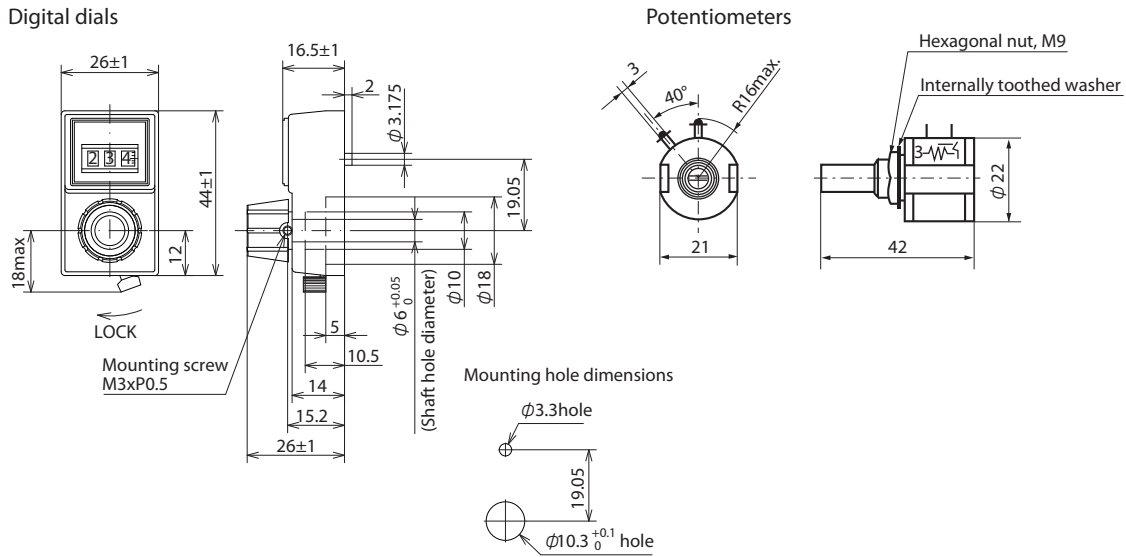

■ AC adapter (No. 81446957-001)

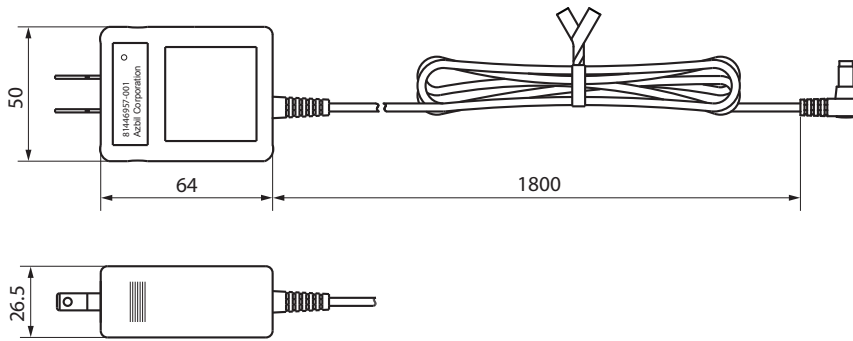



### Customer specifications check sheet for MQV models

Gas types	
Control flow range	Maximum_____ Normal_____ Minimum_____ L/min (normal)
Primary pressure	Maximum_____ Normal_____ Minimum_____ kPa (gauge)
Secondary pressure	Maximum_____ Normal_____ Minimum_____ kPa (gauge)
Fluid/ambient temperature range	Maximum_____ Normal_____ Minimum_____ °C
Connection method	<input type="checkbox"/> UNF <input type="checkbox"/> Rc <input type="checkbox"/> Swagelok <input type="checkbox"/> VCR
Display	<input type="checkbox"/> Integrated display unit <input type="checkbox"/> Separate display unit (with separate 2-m cable)
Communications	<input type="checkbox"/> With RS-485 <input type="checkbox"/> Without RS-485
Gas-contacting parts treated to be oil free	<input type="checkbox"/> Required <input type="checkbox"/> Not required
Traceability certificate / Inspection certificate	<input type="checkbox"/> Inspection Certificate <input type="checkbox"/> Traceability Certificate <input type="checkbox"/> Not required
Analog input/output	<input type="checkbox"/> 4-20 mA <input type="checkbox"/> 1-5 V <input type="checkbox"/> 0-5 V
Length of cables	<input type="checkbox"/> 2 m <input type="checkbox"/> 5 m <input type="checkbox"/> Other_____
Power supply	<input type="checkbox"/> 24 Vdc <input type="checkbox"/> 100 Vac (power outlet)
PC loader	<input type="checkbox"/> Required <input type="checkbox"/> Not required

**Flowmeter installation conditions**

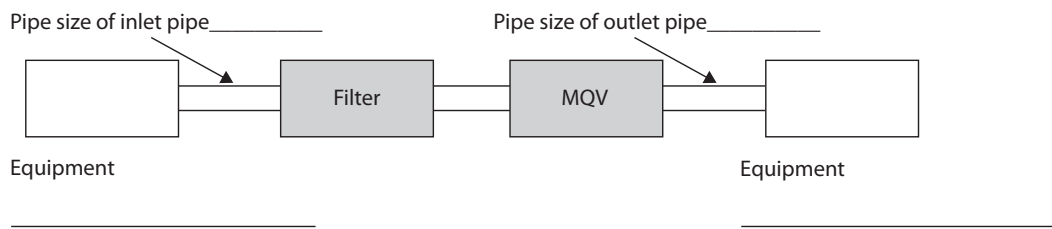





Please read "Terms and Conditions" from the following URL  
before ordering and use.

<http://www.azbil.com/products/factory/order.html>

*Specifications are subject to change without notice.*

**azbil**

**Azbil Corporation**  
Advanced Automation Company

1-12-2 Kawana, Fujisawa  
Kanagawa 251-8522 Japan  
URL: <http://www.azbil.com/>

1st edition: Oct. 2012  
2nd edition: Oct. 2017

*No part of this publication may be reproduced or duplicated  
without the prior written permission of Azbil Corporation.*