

V5832A/5833A,C

SMALL LINEAR VALVES PN16 FOR MODULATING AND ON/OFF-CONTROL

SPECIFICATION DATA

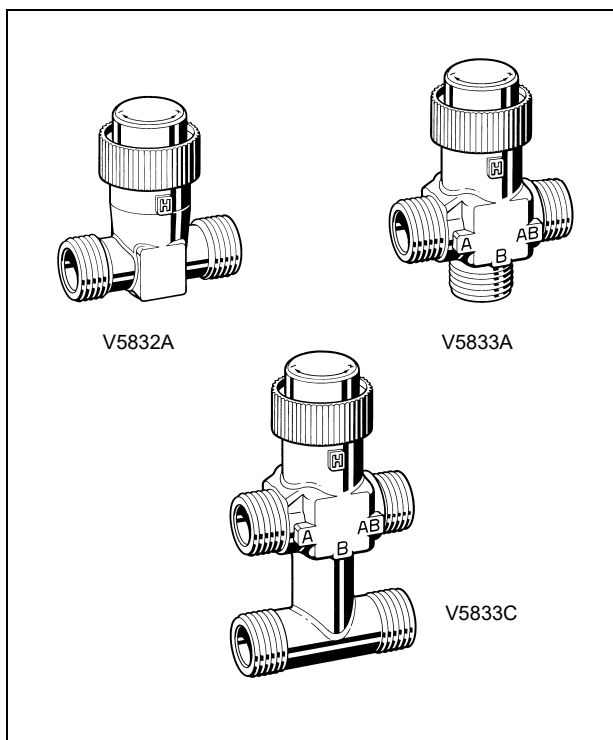

GENERAL

These small linear valves are used in combination with small electric linear valve actuators and thermoelectric actuators for the control of hot and/or chilled water for fan coil units and small reheaters/recoolers in electric/electronic temperature control systems.

FEATURES

- Small size allows installation where space is limited.
- Long stroke results in a high-quality characteristic.
- Soft seat provides low leakage rate and high rangeability.
- Reduced kvs values in the bypass to facilitate hydronic balancing.
- Range of fittings available for different connections (soldered, threaded).
- Adjustment cap for manual operation.
- Flat surfaces on body to fit installation tools.
- Flat sealing connections in standard sizes.
- Valve inserts changeable without draining by using insert replacement tool WV108M.
- 40 mm distance between ports A/AB and the bypass (V5833C, only).

SPECIFICATIONS

Models	Two-way V5832A Three-way V5833A Three-way with bypass V5833C
Operation	Two-way stem up to open, port A to B; Three-way stem up to close, port A to AB
Nominal pressure rating	PN16
Capacity index (kvs)	see tables on page 2 and 3
Leakage rate	≤0.02% of kvs
Valve body	
Material	Brass
Size	DN15 (1/2"), DN20 (3/4")
Trim	
Stem	Stainless steel
Plug	Brass
Suitable medium	Water, with max. 50% glycol
Controlled water temperature	2...120 °C

Modulating valves	
Rangeability	
Two-way valves	100:1
Three-way valves	100:1 for controlled port
Flow characteristic	Equal percentage port A-AB, linear for bypass port B-AB
Stroke	6.5 mm
On/Off valves	
Stroke	2.5 mm
Dimensions	see Fig. 4 on page 5

FLOW CAPACITIES AND CLOSE OFF PRESSURE RATINGS TWO-WAY VALVES

Valve			Close-Off Pressure (kPa) with Actuators		
DN	kvs	Order number	M6410C,L / M7410C,E (180 N)	MT8 (90 N)	MT4 / M7410A (90 N)
15	0.16	V5832A1004	1600	600	-
15	0.25	V5832A1012	1600	600	-
15	0.40	V5832A1020	1600	600	-
15	0.63	V5832A1038	1600	600	-
15	1.00	V5832A1046	1200	180	-
15	1.60	V5832A1053	1200	180	-
20	2.50	V5832A1061	400	50*	-
20	4.00	V5832A1079	400	50*	-
15	1.60	V5832A4008**	1200	180	180
20	2.50	V5832A4016**	400	50*	50*

*Up to 1000kPa system pressure. **For ON/OFF control, stroke 2.5mm.

THREE-WAY VALVES

Valve				Close-Off Pressure (kPa) with Actuators		
DN	kvs A-AB	kvs B-AB	Order Number	M6410C,L / M7410C,E (180 N)	MT8 (90 N)	MT4 / M7410A (90 N)
15	0.25	0.16	V5833A1003	800	500	-
15	0.40	0.25	V5833A1011	800	500	-
15	0.63	0.40	V5833A1029	800	500	-
15	1.00	0.63	V5833A1037	250	150	-
15	1.60	1.00	V5833A1045	250	150	-
20	2.50	1.60	V5833A1052	100	50	-
20	2.50	1.60	V5833A3009	240	-	-
20	4.00	2.50	V5833A1060	100	50	-
20	4.00	2.50	V5833A3017	240	-	-
15	1.60	1.60	V5833A4007*	250	150	150
20	2.50	2.50	V5833A4015*	100	50	50

*For ON/OFF control, stroke 2.5mm.

THREE-WAY VALVES WITH BYPASS

Valve				Close-Off Pressure (kPa) with Actuators		
DN	kvs A-AB	kvs B-AB	Order Number	M6410C,L / M7410C,E (180 N)	MT8 (90 N)	MT4 / M7410A (90 N)
15	0.25	0.16	V5833C1066	800	500	-
15	0.40	0.25	V5833C1009	800	500	-
15	0.63	0.40	V5833C1017	800	500	-
15	1.00	0.63	V5833C1025	250	150	-
15	1.60	1.00	V5833C1033	250	150	-
20	2.50	1.60	V5833C1041	100	50	-
20	2.50	1.60	V5833C1140	240	-	-
20	4.00	2.50	V5833C1058	100	50	-
20	4.00	2.50	V5833C1152	240	-	-
15	1.60	1.60	V5833C4003*	250	150	150
20	2.50	2.50	V5833C4011*	100	50	50

*For ON/OFF control, stroke 2.5mm.

OPERATION

A built-in return spring in the two-way valve produces an opening force. In the three-way valve and the three-way valve with bypass, the spring produces a closing force on the A to AB ports.

The valves are supplied with a screwed-on adjustment cap for manual operation and for protection of the stem. This allows the stem to be set up for filling or initial heating / cooling during the building construction phase without the use of a controller or actuator.

The small electric valve actuators as well as the thermo-electric actuators provide automatic control over the opening and closing movement of the valve stem.

TYPICAL OPERATION

All types of valves should be mounted in the return flow. If the Δp -values exceed 60 kPa, attention should be paid to the development of noise.

Two-Way Valves

Direction of flow always from port A to port B
Port B: Outlet

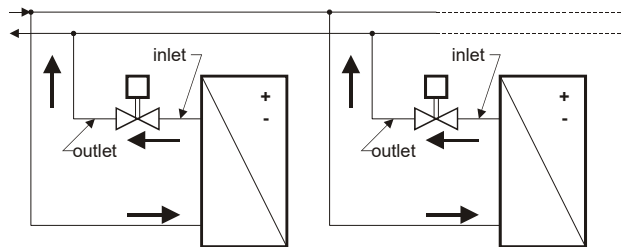

Fig. 1. Two-way valve operation

Three-Way Valves

These valves are preferably used as mixing valves, this means:

- Port AB: Total flow outlet
- Port A: Controlled flow inlet
- Port B: Bypass inlet

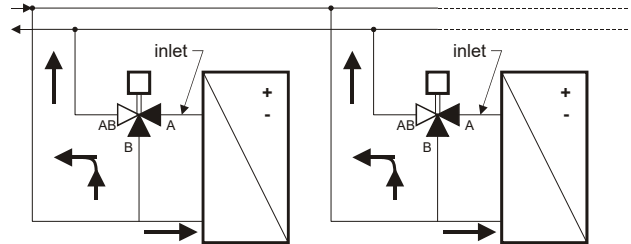

Fig. 2. Three-way valve operation

Three-Way Valves with Bypass

These valves simplify the installation, which is depending on the layout of the pipework, as the bypass pipe is part of the valve. The information for the normal three-way valves is also valid for this type.

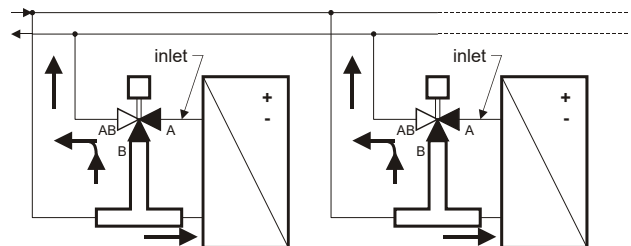

Fig. 3. Three-way valve with bypass

MOUNTING

When installing the valve, care must be taken that the flow direction is correct (see section "Typical Operation"). The valve must not be mounted with the stem pointing downward.

The adjustment cap must be removed from the valve only when the actuator is fitted. The valve should be installed as stress-free as possible with a tightening torque of 25 to 30 Nm.

The valve is supplied complete with mounting instructions. The water quality must meet VDI 2035 requirements.

ACCESSORIES

Valves V5832A need two connection sets, valves V5833A three connection sets, and valves V5833C four connection sets.

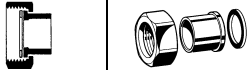
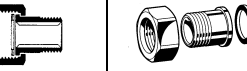
Connection	Pipe Size	DN	Order Number	Connection Set		Description
Soldering	12 mm 15 mm	15 20	AC-15FS AC-20FS			Consisting of 1 union nut, 1 solder bush, and 1 gasket
External Thread	R3/8" R1/2"	15 20	AC-15FT AC-20FT			Consisting of 1 union nut, 1 tailpiece, and 1 gasket

*Cannot be purchased from Honeywell

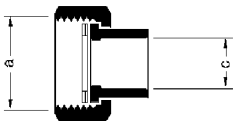
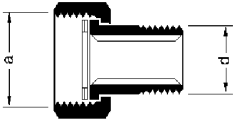
	Dimensions of Connection Sets			Order Number
	a	c	d	
	G1/2" G3/4"	12 mm 15 mm		AC-15FS AC-20FS
	G1/2" G3/4"		R3/8" R1/2"	AC-15FT AC-20FT

DIMENSIONS

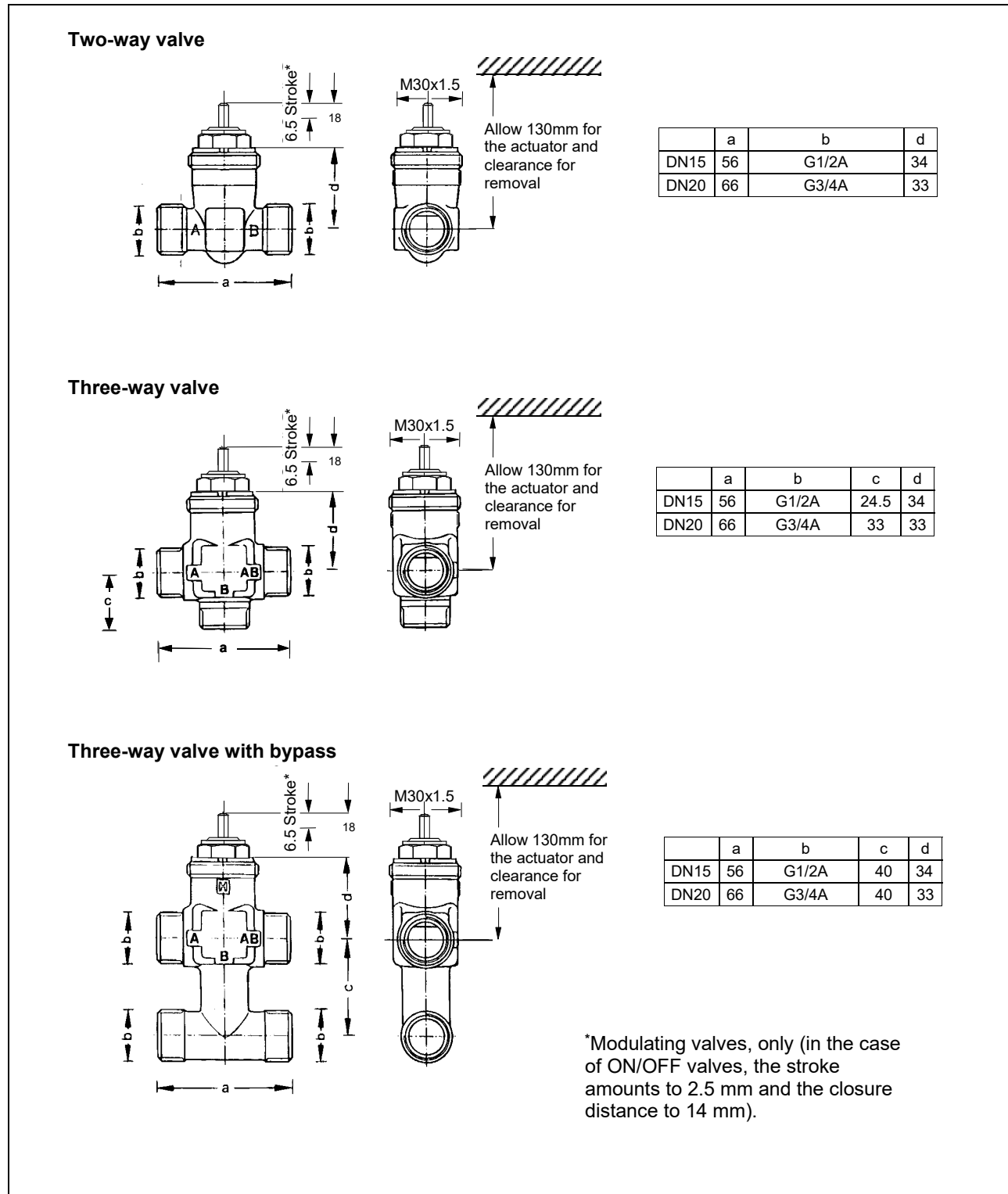

Fig. 4. Dimensions V5832A/V5833A,C in mm

SPARE PARTS

Valve inserts are provided as spare parts for the V5832A and V5833A,C small linear valves. When the tool WV108M is used, the valve inserts can be changed without draining the system.

Order Number	DN	kvs	Order Number Valve Insert
V5832A1004	15	0.16	0902812
V5832A1012	15	0.25	0902811
V5832A1020	15	0.40	0902810
V5832A1038	15	0.63	0902809
V5832A1046	15	1.00	0902808
V5832A1053	15	1.60	0902807
V5832A1061	20	2.50	0902814
V5832A1079	20	4.00	0902815
V5832A4008*	15	1.60	0902813
V5832A4016*	20	4.00	0902816

*For ON/OFF control

Order Number	DN	kvs	Order Number Valve Insert
V5833A1003 / V5833C1066	15	0.25	0902821
V5833A1011 / V5833C1009	15	0.40	0902822
V5833A1029 / V5833C1017	15	0.63	0902823
V5833A1037 / V5833C1025	15	1.00	0902824
V5833A1045 / V5833C1033	15	1.60	0902825
V5833A1052 / V5833C1041	20	2.50	0902826
V5833A3009 / V5833C1140	20	2.50	0902818
V5833A1060 / V5833C1058	20	4.00	0902827
V5833A3017 / V5833C1152	20	4.00	0902819
V5833A4007* / V5833C4003*	15	1.60	0902817
V5833A4015* / V5833C4011*	20	2.50	0902820

*For ON/OFF control

The following valve inserts are interchangeable

- Two-way valves:
 - kvs 0.16, 0.25, 0.40, and 0.63
 - kvs 1.0 and 1.6
 - kvs 2.5 and 4.0
- Three-way valves:
 - kvs 0.25, 0.40, 0.63, and 1.0
 - kvs 2.5 and 4.0



Manufactured for and on behalf of the Environmental & Energy Solutions Division of Honeywell Technologies Sàrl, Rolle, Z.A. La Pièce 16, Switzerland by its Authorized Representative:

Home and Building Technologies

Honeywell GmbH
 Böblinger Strasse 17
 71101 Schönaich, Germany
 Phone +49 (0) 7031 637 01
 Fax +49 (0) 7031 637 740
<http://ecc.emea.honeywell.com>



www.instrumentteam.no

post@instrumentteam.no